

WOLFBOX

Dare to Everywhere

G850

MIRROR DASH CAM

User Manual

wolfbox.com

The information in this manual is subject to change without notice.

General Overview

Precautions	I
Warnings	I
Product Overview	II
Warranty	II
Package Contents	III

After-Sales

Customer Service Center	113
-----------------------------------	-----

Language

English	1
Deutsch	23
Français	46
Italiano	68
Español	90

Precautions

1. For further inquiries, please contact our customer service via email at service@wolfbox.com.
2. Please use original accessories to avoid compatibility issues and insufficient current supply from non-compatible accessories. For example, 2-in-1 or 3-in-1 cigar sockets will not provide enough current to the device.
3. Please do not tamper or splice the rear camera wire for the purpose of extension, as the rear image/feed to the display may be lost. The length of the included cable for the rear camera is 20 feet, and is suitable for most types of cars.
4. If you wish to use a micro SD card with a capacity > 32GB, Please change the micro SD card [Class10 (10MB/s) required] format to FAT 32 on PC.

Warnings

- Keep small accessories out of the reach of children. If this product is damaged or malfunctions, stop using it immediately and contact WOLFBOX support. Continued use may cause fire, electric shock or vehicle failure.
- This product is intended to be used as reference material in the event of an accident. We do not guarantee its effectiveness or admission as complete evidence.
- Please note that this product may infringe on privacy and other rights depending on how it is used. We are not responsible for any cases where this product infringes on privacy or other rights.
- This product is for DC12V/24V vehicles only.



- The specifications and appearance of this product are subject to change without notice for improvement.

Product Overview

- Thank you for choosing WOLFBOX G850 Mirror Dash Cam. This product provides a high-quality image and captures irrefutable evidence in the event of an accident, and records the beauty along the way for you.
- WOLFBOX is a professional automotive supplies manufacturing company. We have worked in the field of dash cams for more than ten years. We have a team of experienced and imaginative engineers who are committed to building a reliable and trustworthy automotive supplies brand.

Warranty

- We are committed to giving customers the best product experience and after-sale service.
- Our warranty period is 18 months. If the machine parts are damaged or there are any problems during use, we will solve them in time and provide you with a satisfactory shopping experience.

Note: The specific warranty period is subject to local laws.

- Please contact us with your online order, and we will provide free replacement and lifetime technical support.
- **Free extended warranty service:** After registering information on WOLFBOX.com, you may extend the warranty for an additional 6 months free of charge.

URL: <https://wolfbox.com/pages/warranty-form>



Package Contents

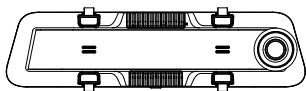

• 4K Mirror Dash Cam

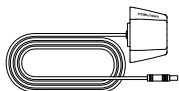

• 1080P Rear Camera

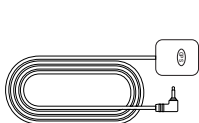

• GPS

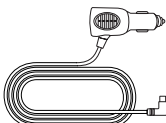

• Power Supply Cable with Car Charger

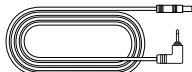

• Rear Cam Cable



• Adhesive

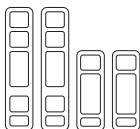

• Rubber Straps*4



• Tool



• User Manual



• Cable Clips*5



Content

Product Specifications	1
Appearance	2
User Interface Overview	3
Feature Overview	5
Voice Control Feature	11
Play on APP (About Wi-Fi and APP)	12
How to Play Video on Computer	13
Installation	15
Trouble Shooting	21

Product Specifications

RAM	DDR3 2Gb	Display Type	IPS
Video Format	MP4	Image Format	JPG
Front Camera	4K	Rear Camera	1080P
Display Size	12"	Rear Lens FPS	25 fps
Power Interface	USB-C	GPS	External, 3.5mm headphone interface
Wi-Fi Connection	Supported	Voice Control	Supported
Operating Temperature	-4°F ~158°F	Full Touch Screen	Supported
SD Card	Max Support 512GB		



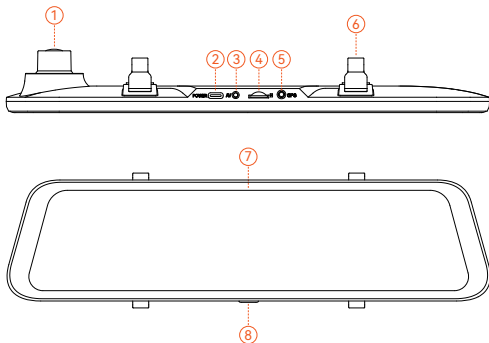







Appearance





NO.	Name	Description
1	Lens	Front lens, records the front view of the car
2	USB-C Port	Port for power supply/connection
3	Rear camera connector	Port used to connect the rear camera
4	TF card slot	Provides expandable storage (class 10 Max 256GB)
5	GPS connector	Used to connect GPS module (GPS function requires optional GPS antenna)
6	Fasteners	The machine can be held in position with 2 straps
7	Display screen	12" touch screen display
8	Power button	Short press to wake up/sleep, long press to power on/off

User Interface Overview











icon	Description
	Speed & Driving Direction: Once GPS is connected, the proper information will be displayed
	Date & Time
	Turn on/off the device sound
	Turn on/off Wi-Fi
	View voice command entries
	Start / Stop Recording
	Adjust the screen brighten
	Switching between front, rear and split-screen camera view
	Snapshot: Take a Snapshot
	Recording Status: Flashing yellow indicates Lock-Recording

icon	Description
	File Playback: Playback the video & photo
	Turn on/off audio recording
	Settings: Tap to enter the settings menu

• Playback Mode







When you power on the dash cam, it will start recording automatically. Click/select  to enter playback mode.















	Stores images captured by the front camera		Stores images captured by the rear camera
	Normal Video: Select it to view recorded videos		Locked Video: Select it to check locked videos
	Photos: Select it to check photos		Select
	Delete		Lock the video
	View videos on full screen		







Feature Overview







Click the setting icon to enter the function menu, where you can adjust various functions and parameters of the entire machine.



Function	Option	Description
 Resolution	4K30fps+1080P25fps/ 2.5K30fps+1080P25fps/ 1080P30fps+1080P25fps	Video resolution selection.
 Display Modes	F-cam/R-cam /Split Screen	Set the default video recording interface display screen upon startup.
 Sound Record	ON/OFF	Set whether to record sound.
 Loop Recording	1 Minute/2 Minutes /3 Minutes	Set the duration for loop recording of video files.
 G-Sensor	OFF/Low/Medium /High	Set the sensitivity of the G-sensor.
 Fatigue Reminder	OFF/1 Hour /2 Hours/3 Hours	Set the time for fatigue reminder.

Function	Option	Description
 Wi-Fi	ON/OFF	Set the status of the device's Wi-Fi connection.
 Volume Setting	OFF/Low/Medium /High	Set the volume level of the device.
 Click Tone	ON/OFF	Set the switch for key tones.
 Screen Saver	OFF/10 Seconds /30 Seconds /2 Minutes	Set the activation time for the screen saver.
 Screen Brightness	/	Adjust the screen brightness.
 Exposure	/	Adjust the contrast of the front camera.
 Voice Control	ON/OFF /Voice Command	Set the switch for voice control functionality.

Function	Option	Description
 <p>Mirror Flip</p>	ON/OFF	Adjust the left-right flip of the rear camera image.
 <p>Rear cam Flip</p>	ON/OFF	Adjust the up-down flip of the rear camera image.
 <p>Reversing Line</p>	ON/OFF	Set the switch for the reversing line display function.
 <p>Parking Mode</p>	ON /G-Trigger Recording /12H Time-lapse recording /24H Time-lapse recording /48H Time-lapse recording	Monitor the vehicle's status after the engine is turned off.
 <p>GPS</p>	/	Display recorded GPS data.
 <p>GPS Display</p>	ON/OFF	Set whether to display GPS information on the recording interface.

Function	Option	Description
 Date Stamp	ON/OFF	Set the switch for time watermark.
 Speed Stamp	ON/OFF	Set the switch for speed watermark.
 GPS Stamp	ON/OFF	Set the switch for GPS watermark.
 Speed Unit	KM/H / MPH	Set the unit for speed display.
 Language	English/Français/ Deutsch/Italiano/ Español/...	Set the language for the device.
 Clock Setting	/	Adjust the current time displayed on the device.
 Time Format	YY-MM-DD /DD-MM-YY /MM-DD-YY	Set the time display format.

Function	Option	Description
 Time Style	12 Hours/24 Hours	Set the time display system.
 Time Zone	/	Adjust the time zone based on geographical location.
 DST	ON/OFF	Set the switch for daylight saving time.
 Flicker	50 Hz/60 Hz	Set the screen refresh rate.
 Help Center	/	After-sales contact information.
 Format Reminder	OFF /Each 15 days /Each 25 days	Set the reminder for formatting the SD card.
 Format SD Card	/	Format the SD card and delete videos and photos stored on it.

Function	Option	Description
 Reset Setup	/	Restore all settings to factory defaults.
 APP	/	Provide QR code for downloading the app.
 Product Information	/	Display device information.

Note:

Parking Mode requires a hardware kit (purchased separately) in order to activate.

With the hardware kit connected and Parking Mode enabled, the dash cam will enter Lapse Recording mode when the car turns off. This mode captures video at 1 frame per second until the set duration ends or the car battery voltage drops below 12V.

Voice Control Feature

Fast control through simple voice commands.

When the recording interface displays a white icon , it means that the Voice Control feature is activated.

You can enable/disable the voice control feature through the "Voice Control" in the menu.

lock the video	
take picture	
turn on audio	turn off audio
turn on screen	turn off screen
turn on Wi-Fi	turn off Wi-Fi
turn on recording	turn off recording
show front camera	show rear camera

Note:

You have two ways to view specific voice control commands:

- 1 Tap on the voice control icon  on the recording interface.
- 2 Tap on the "Voice Command" submenu under the "Voice Control" feature.

Play on APP (About Wi-Fi and APP)

The Wi-Fi feature has been designed so you can pair your dash camera wirelessly with your smartphone and access your recordings instantly from the dash cam. Here you can view, download and share your videos easily with your friends and family.

The app “WOLFBOX” is a free app that allows you to operate this WLAN built-in drive recorder from your smartphone.

• How to connect Wi-Fi?

1. Download the “WOLFBOX ” app

Go to the following address to download the “ WOLFBOX” app: <https://wolfbox.com/app/> You may also use your smartphone to scan the QR code to go to the download page.



2. Enable Wi-Fi

Go to Settings to turn on Wi-Fi. Go to Settings to turn on the Wi-Fi. Then, the device screen will display the Wi-Fi name and password.

3. Connect Wi-Fi

To connect your iPhone or Android phone to the G850's Wi-Fi network, go to Settings > Wi-Fi and select G850 Wi-Fi. Then, enter the default **password: 12345678**.

4. Open the “WOLFBOX” app

Once your mobile phone is connected to the G850's Wi-Fi network, open the WOLFBOX app. The camera will sync automatically, and you should see the live video feed on your phone.

- **Edit and share Your Videos in the App**

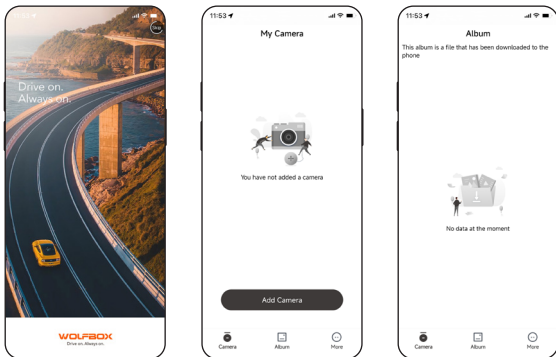

In the app, you can view and edit downloaded local albums and share them with others.

How to Play Video on Computer

We recommend the application “GPS Media Player” to watch and play dash cam videos, and view Google Maps.

You can download it for free on Mac or Windows from the following link: <https://wolfbox.com/gps-player/>

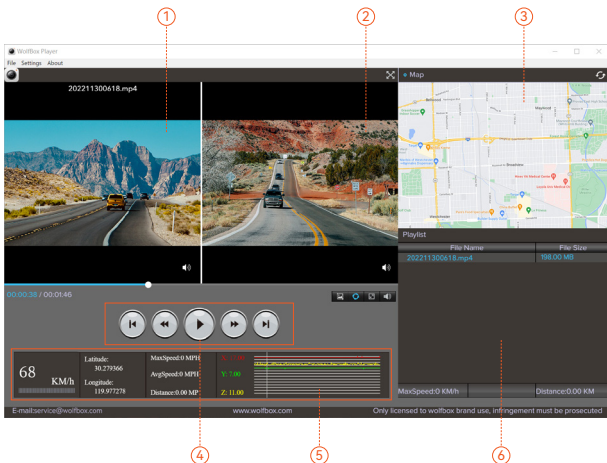

- ① Video play window (Front)
- ② Video play window (Rear)
- ③ Map and track display
- ④ Play control panel
- ⑤ Speed and driving state indication
- ⑥ Play list

Note:

If you record the front and rear dash cam videos simultaneously and add them to the playlist, you can play them side by side in split-screen mode.

To play a video file, drag and drop it onto the video player.

Installation

Before installing your dash cam, please test its functionality with all accessories and change the default settings to your preference.

• SD card installation

Ensure that the dash cam is powered off when inserting or ejecting the SD card.

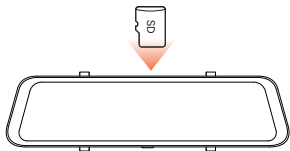

• The Front view of the host

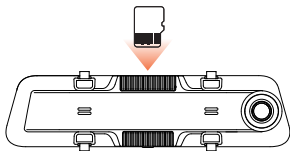

• The Back view of the host

• Unit installation

1. Place the head unit (WOLFBX Mirror) on the rear-view mirror by hand, and be sure to separate the silicone brackets on both sides of the rearview mirror. Buckle the device to the rearview mirror with the rubber straps. Adjust the front lens to a desired angle.

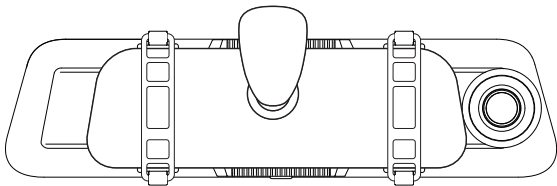

2. Connect the car charger to the charger adapter to supply power for the dash cam.

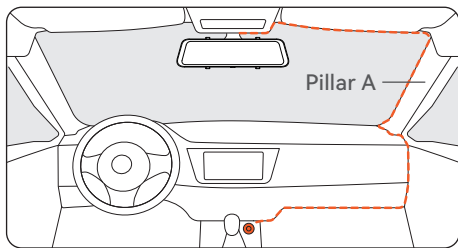

- **Power ON/OFF**

- Short press the power button to turn on, long press the power button to turn off.
- When using the car charger, if the cigarette lighter port is ACC, the dash cam will automatically turn on when the car is started.

- **Rear camera installation**

If you don't need to adjust the angle, you can remove this iron plate.

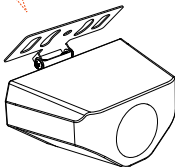

- Outside the car bracket

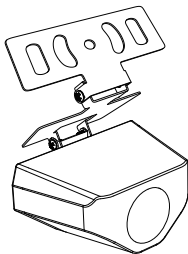

- Inside the car bracket

• Rear Camera Wiring Instructions

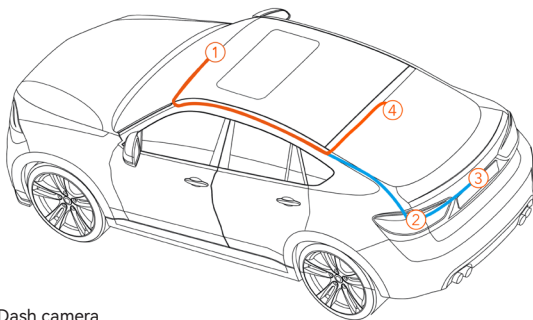

① Dash camera

② Connected to reversing light

③ Outside the car bracket

④ Inside the car bracket

Note:

The rear camera has two wire routing options, both of which conceal the wire along the edges of the door.

1. Connect the rear camera cable to the mirror

Plug the rear camera cable into the AV interface of the unit.

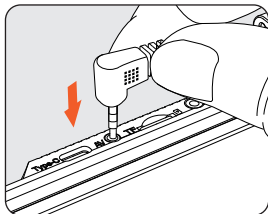

2. Rear camera cable routing

Route the rear camera cable to the rear of the car, leaving some slack. Insert the cable into the gap in the front windshield and along the upper end of the door using the included tool.

If you choose to install the rear camera inside your car, fix it on the rear windshield after routing the wiring.

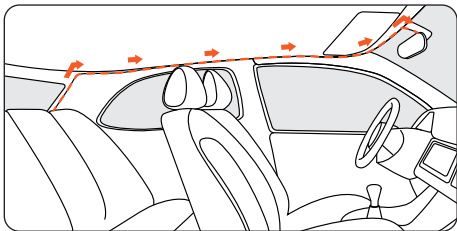

3. Remove the panel

Open the trunk and remove the interior panel that covers the other side of the license plate mount area. Use a trim removal tool or other thin device to pry the panel open.

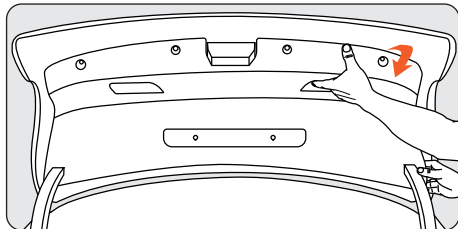

4. Fix the rear camera and connect the cables

Fix the rear camera near the license plate light with adhesive, and connect the rear camera cable through the license plate light hole to the rear camera cable.

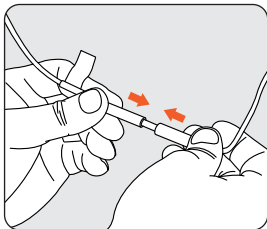
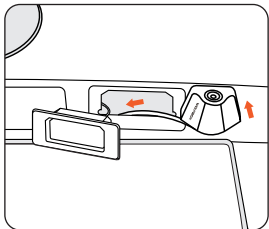

5. Connect the red wire to the reverse light's positive terminal

Find the positive terminal of the reverse light. This is the terminal that has voltage when the car is in reverse gear. To find it, step on the brakes, put the car in reverse gear and measure the voltage at each terminal. The terminal with voltage is the positive terminal. Strip the positive cable and wrap it with the red cable from the camera. Insulate the connection with electrical tape. Test the connection by putting the car in reverse gear and seeing if the dash cam enters reverse mode.

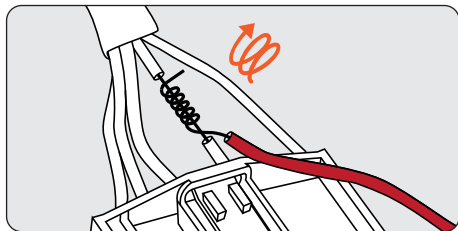

• GPS Installation

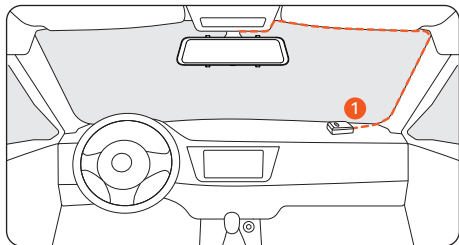

Position 1:

Install the dash cam in the right corner of the central console and hide the wiring along the edge of the front windshield using double-sided tape.

- Considering the use effect and installation convenience, we usually recommend customers install it at position 1.
- You may also test different locations for the dash cam to find the one that works best for you. Just make sure that the black side is facing up to receive the GPS signal.
- Once the GPS is installed, the GPS icon on the home screen will appear. After the GPS signal has been received, the device's GPS will show direction and speed.



Trouble Shooting

- **Can the Wi-Fi feature be obtained by upgrading the firmware?**

The G850 Wi-Fi is a hardware upgrade from a previous version, and its Wi-Fi feature cannot be available through a firmware upgrade.

- **Can rear camera images be transmitted wirelessly?**

The G850 Wi-Fi comes with a rear camera cable through which the rear camera video is transmitted. The Wi-Fi feature is only used to connect the phone to the dash cam.

- **Is it possible to monitor the vehicle remotely via Wi-Fi on the G850?**

Considering the limited Wi-Fi range, it is not possible to monitor the vehicle remotely via the App connecting to G850.

- **Rear camera image blurred or not detected?**

For "Blurred rear image" issue, please make sure that the protective film on the lens is removed and wipe the lens with a cleaner. If the focusing issues are caused by high temperatures, please contact us for support.

If you are getting a "Rear camera not detected" error, check the AV input on the top of the mirror and the rear camera cable for damage, especially at the connector.

- **How to connect the unit to App via Wi-Fi?**

1. Please make sure that Wi-Fi is turned on manually in settings.
2. Search for "WOLFBOX" in the app store to download the latest version of the app.
3. Check the Wi-Fi list on your smartphone to see if the network named "WOLFBOX" can be found.
4. If the app displays "Connection Failed", please find "Get Support" in the app to contact us.

Inhalt

Produktspezifikationen	24
Erscheinungsbild	25
Benutzeroberfläche Übersicht	26
Funktionsübersicht	28
Auf APP spielen(Über WIFI und APP)	35
Wie man Video auf dem Computer Abspielt	36
Installation	38
Fehlerbehebung	44

Produkt Spezifikationen

RAM	DDR3 2Gb	Anzeige Typ	IPS
Video-Format	MP4	Bildformat	JPG
Frontkamera	4K	Rückfahrkamera	1080P
Display Größe	12"	Hintere Lines FPS	25fps
Stromversorgungs-Schnittstelle	USB-C	GPS	Extern, 3,5-mm-Kopfhöreranschluss
Wi-Fi-Verbindung	Angenommen	Contrôle vocal	Angenommen
Betriebstemperatur	-4° F ~158° F	Voller Touchscreen	Angenommen
SD-Karte	Max Suppok 512 GB		



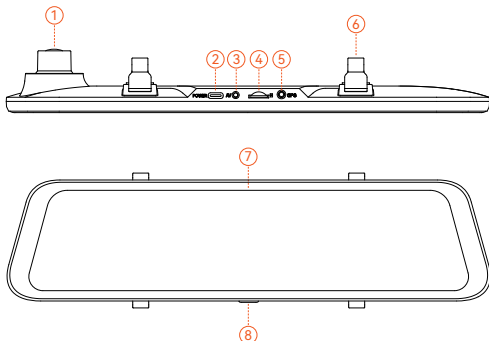





Erscheinungsbild





NEIN.	Name	Beschreibung
1	Objektiv	Frontlinse, nimmt die Frontansicht des Fahrzeugs auf
2	USB-C Pok	Pok für Stromversorgung/Verbindung
3	Anschluss für Rückfahrkamera	Pok für den Anschluss der Rückfahrkamera
4	TF-Kartenschlitz	Bietet erweiterbaren Speicher (Klasse 10, maximal 256 GB)
5	GPS-Anschluss	Dient zum Anschluss des GPS-Ports (GPS-Funktion erfordert optionale GPS-Antenne)
6	Befestigungselemente	Die Maschine kann mit 2 Gurten in Position gehalten werden
7	Bildschirm	12-Zoll-Touchscreen-Display
8	Einschalttaste	Kurzes Drücken zum Aufwachen/Einschlafen, langes Drücken zum Einschalten/Ausschalten

Benutzeroberfläche-Übersicht











Symbol	Beschreibung
	Geschwindigkeit und Fahrtrichtung: Sobald das GPS verbunden ist, werden die entsprechenden Informationen angezeigt
	Datum und Uhrzeit
	Geräteton ein/aus
	WLAN ein/aus
	Sprachbefehleinträge anzeigen
	Aufnahme ein/aus
	Einstellen der Bildschirmhelligkeit
	Umschalten zwischen Front-,Rück- und Split ScreenKameraansicht
	Schnappschuss: Einen Schnappschuss machen
	Aufnahmestatus: Blinkendes Gelb zeigt Sperr-Aufnahme an

Symbol	Beschreibung
	Datei-Wiedergabe: Wiedergabe der Videos und Fotos
	Audioaufnahme ein-/ausschalten
	Einstellungen: Tippen Sie auf , um das Einstellungsmenü aufzurufen.

• Wiedergabemodus

Wenn Sie die Dashcam einschalten, beginnt sie automatisch mit der Aufnahme. Klicken Sie auf  , um in den Wiedergabemodus zu gelangen.















	Speichert Bilder von der Frontkamera		Speichert Bilder von der Rückfahrkamera
	Normalvideo: Wählen Sie es aus, um aufgenommene Videos anzuzeigen		Gesperrt Video: Wählen Sie es aus, um gesperrte Videos zu überprüfen
	Fotos: Wählen Sie es aus, um Fotos zu überprüfen		Auswählen
	Löschen		Zum Sperren des Videos
	Videos im Vollbildmodus ansehen		







Funktionsübersicht

Klicken Sie auf das Einstellungssymbol, um das Funktionsmenü aufzurufen, in dem Sie verschiedene Funktionen und Parameter der gesamten Maschine einstellen können.

Funktion	Option	Beschreibung
 Auflösung	4K30fps+1080P25fps/ 2.5K30fps+1080P25fps/ 1080P30fps+1080P25fps	Auswahl der Videoauflösung.
 Anzeigemodi	Frontkamera/ Rückfahrkamera/ Geteilter Bildschirm	Legen Sie beim Start den Standard-Anzeigebildschirm für die Videoaufnahme fest.
 Tonaufnahme	EIN/AUS	Legen Sie fest, ob Ton aufgezeichnet werden soll.
 Dauer der Aufzeichnung	1 Minute/2 Minutes /3 Minutes	Stellen Sie die Dauer der Schleifenaufzeichnung ein.
 Kollisionsempfindlichkeit	AUS/Hoch/Mittel/ Niedrig	Nach der Erkennung einer Kollision/eines Aufpralls sperrt das Gerät das aufgezeichnete Video.
 Fatigue Reminder	OFF/1 Stunde/2 Stunden/3 Stunden	Stellen Sie die Zeit für die Ermüdungswarnung ein.

Funktion	Option	Beschreibung
 Wi-Fi	EIN/AUS	Stellen Sie die Aktivierungszeit für den Bildschirmschoner ein.
 Lautstärke	AUS/Hoch/Mittel/ Niedrig	Stellen Sie die Lautstärke ein.
 Klickton	EIN/AUS	Stellen Sie den Schalter für Tastentöne ein.
 Bildschirm- schoner	AUS/10 Sekunden/30 Sekunden/2 Minuten	Stellen Sie den Status der WLAN-Verbindung des Geräts ein..
 Bildschirmhelligkeit	/	Stellen Sie die Bildschirmhelligkeit ein.
 Belichtung	/	Stellen Sie den Kontrast der Frontkamera ein.
 Sprachsteuerung	EIN/AUS/ Sprachbefehle	Stellen Sie den Schalter für die Sprachsteuerungsfunktion ein.

Funktion	Option	Beschreibung
 Spiegel umdrehen	EIN/AUS	Stellen Sie die Links-Rechts-Umkehr des Rückfahrkamera-Bildes ein.
 Rückfahrkamera umdrehen	EIN/AUS	Stellen Sie die Oben-Unten-Umkehr des Rückkamera-Bildes ein.
 Rückwärtsfahrende Linie	EIN/AUS	Stellen Sie den Schalter für die Rückfahrlinien-Anzeigefunktion ein.
 Parking Mode	EIN/G-Auslöser für die Aufzeichnung/12 Stunden Zeitraffer-Aufnahme/24 Stunden Zeitraffer-Aufnahme/48 Stunden Zeitraffer-Aufnahme	Überwachen Sie den Status des Fahrzeugs, nachdem der Motor ausgeschaltet ist.
 GPS	/	Zeigen Sie die aufgezeichneten GPS-Daten an.
 GPS-Anzeige	EIN/AUS	Stellen Sie ein, ob GPS-Informationen auf der Aufnahmeoberfläche angezeigt werden sollen.

Funktion	Option	Beschreibung
 Datumsstempel	EIN/AUS	Stellen Sie den Schalter für das Datumsstempel ein.
 Geschwindigkeitsstempel	EIN/AUS	Stellen Sie den Schalter für das Geschwindigkeitsstempel ein.
 GPS-Stempel	EIN/AUS	Stellen Sie den Schalter für das GPS-Stempel ein.
 Geschwindigkeitseinheit	KM/H / MPH	Stellen Sie die Einheit für die Geschwindigkeitsanzeige ein.
 Sprache	English/Français/ Deutsch/Italiano/ Español/...	Stellen Sie die Sprache für das Gerät ein.
 Einstellung der Uhr	/	Stellen Sie die aktuelle Zeit auf dem Gerät ein.
 Zeitformat	YY-MM-DD/DD-MM-YY/MM-DD-YY	Stellen Sie das Zeitanzeigeformat ein.

Funktion	Option	Beschreibung
 Zeitstil	12 Stunden/24 Stunden	Stellen Sie das Zeitanzeigesystem ein.
 Zeitzone	/	Stellen Sie die Zeitzone basierend auf der geografischen Lage ein.
 Sommerzeit	EIN/AUS	Stellen Sie die Umschaltung für die Sommerzeit ein.
 Flackern- Frequenz	50 Hz/60 Hz	Kundendienst- Kontaktinformationen.
 Hilfe-Center	/	Stellen Sie die Erinnerung zur Formatierung der SD-Karte ein.
 Format Reminder	AUS /Alle 15 Tage /Alle 25 Tage	Stellen Sie die Erinnerung zur Formatierung der SD-Karte ein.
 SD-Karte formatieren	/	Formatieren Sie die SD-Karte und löschen Sie die darauf gespeicherten Videos und Fotos.

Funktion	Option	Beschreibung
 Setup zurücksetzen	/	Stellen Sie alle Einstellungen auf die Werkseinstellungen zurück.
 APP	/	Stellen Sie einen QR-Code zum Herunterladen der App bereit.
 Produktdaten	/	Zeigen Sie Geräteinformationen an.

Anmerkung:

Für die Aktivierung des Parkmodus ist ein Hardware-Kit (separat erhältlich) erforderlich.

Wenn das Hardware-Kit angeschlossen und der Parkmodus aktiviert ist, wechselt die Dashcam in den ZeitrafferAufnahmemodus, wenn das Fahrzeug ausgeschaltet wird. Dieser Modus nimmt Videos mit 1 Bild pro Sekunde auf, bis die eingestellte Dauer endet oder die Spannung der Autobatterie unter 12 V fällt.

Sprachsteuerungsfunktion

Schnelle Steuerung durch einfache Sprachbefehle

Wenn das Symbol  weiß ist, bedeutet dies, dass die Funktion normal verwendet werden kann.

Sie können die Sprachsteuerungsfunktion über „Sprachsteuerung“ im Menü aktivieren/deaktivieren.

lock the video	
take picture	
turn on audio	turn off audio
turn on screen	turn off screen
turn on Wi-Fi	turn off Wi-Fi
turn on recording	turn off recording
show front camera	show rear camera

Anmerkung:

Sie haben zwei Möglichkeiten, um spezifische Sprachsteuerungsbefehle einzusehen:

- 1 Tippen Sie auf das Symbol für die Sprachsteuerung



in der Aufnahmeoberfläche.

- 2 Tippen Sie auf das Untermenü „Sprachbefehl“ unter der Funktion „Sprachsteuerung“.

Auf APP Spielen(Über WIFI und APP)

Die Wi-Fi-Funktion wurde entwickelt, damit Sie Ihre Dashcam drahtlos mit Ihrem Smartphone koppeln und sofort von der Dashcam aus auf Ihre Aufnahmen zugreifen können. Hier können Sie Ihre Videos ansehen, herunterladen und ganz einfach mit Ihren Freunden und Ihrer Familie teilen.

Die App "Wolfbox" ist eine kostenlose App, mit der Sie diesen im WLAN eingebauten Drive-Recorder über Ihr Smartphone bedienen können.

• Wie stellt man eine Wi-Fi-Verbindung her?

1. Laden Sie die App "Wolfbox" herunter

Bitte gehen Sie zu folgender Adresse, um die "Wolfbox"-App herunterzuladen: <https://wolfbox.com/app/> Sie können auch mit Ihrem Smartphone den QR-Code scannen, um zur Download-Seite zu gelangen.



2. Wi-Fi aktivieren

Gehen Sie zu Einstellungen, um Wi-Fi einzuschalten. Gehen Sie zu Einstellungen, um das Wi-Fi einzuschalten. Dann werden auf dem Bildschirm des Geräts der Wi-Fi-Name und das Passwort angezeigt.

3. Wi-Fi verbinden

Um Ihr iPhone oder Android-Telefon mit dem Wi-Fi-Netzwerk des G850 zu verbinden, gehen Sie zu Einstellungen > Wi-Fi und wählen Sie G850 Wi-Fi. Geben Sie dann das Standardpasswort ein: 12345678.

4. Öffnen Sie die "Wolfbox"-App

Sobald Ihr Mobiltelefon mit der Wi-Fi-Verbindung des G850 verbunden ist Fi-Netzwerk, öffnen Sie die WOLFBX-App. Die Kamera wird automatisch synchronisiert, und Sie sollten die Live Videoübertragung auf Ihrem Telefon sehen.

• Bearbeiten und teilen Sie Ihre Videos in der App

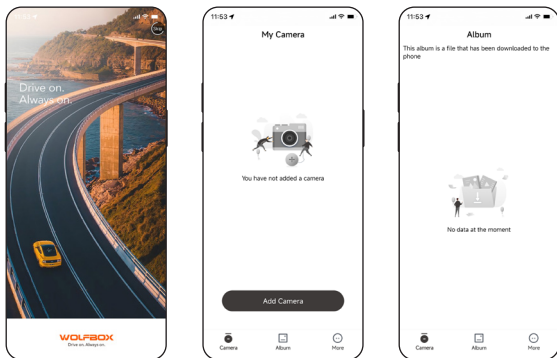

In der App können Sie heruntergeladene lokale Alben ansehen und bearbeiten und sie mit anderen teilen.

Wie man Video auf dem Computer abspielt

Wir empfehlen die Anwendung "GPS Media Player", um Dashcam-Videos anzusehen und abzuspielen und Google Maps anzuzeigen. Sie können es kostenlos für Mac oder Windows unter folgendem Link herunterladen: <https://wolfbox.com/gps-player/>

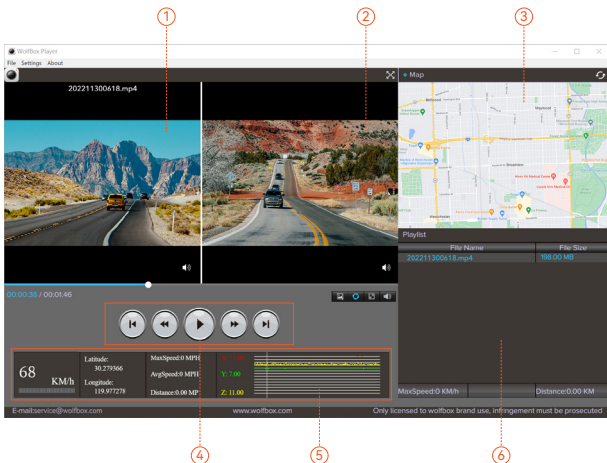

- ① Video-Wiedergabefenster (Vorderseite)
- ② Video-Wiedergabefenster (Rückseite)
- ③ Karten- und Streckenanzeige
- ④ Bedienfeld für die
- ⑤ Wiedergabe Anzeige von Geschwindigkeit und
- ⑥ Fahrzustand Abspieliste

Anmerkung:

Wenn Sie die Videos der vorderen und hinteren Dashcam gleichzeitig aufnehmen und zur Wiedergabelistehinzufügen, können Sie sie im geteilten Bildschirm nebeneinander abspielen. Um eine Videodatei abzuspielen, ziehen Sie sie auf den Videoplayer und legen Sie sie dort ab.

Installation

Bevor Sie Ihre Dashcam installieren, testen Sie bitte die Funktionalität mit allen Zubehörteilen und ändern Sie die Standardeinstellungen nach Ihren Wünschen.

• SD-Karten-Installation

Stellen Sie sicher, dass die Dashcam ausgeschaltet ist, wenn Sie die SD-Karte einlegen oder auswerfen.

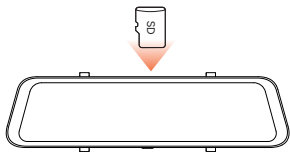

• Die Vorderansicht des Hosts

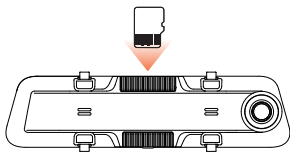

• Die Rückansicht des Hosts

• Einbau der Einheit

1. Setzen Sie die Kopfeinheit (Wolfbox Mirror) mit der Hand auf den Rückspiegel, und achten Sie darauf, die Silikonhalterungen auf beiden Seiten des Rückspiegels zu trennen. Befestigen Sie das Gerät mit den Gummiriemen am Rückspiegel. Stellen Sie die Frontlinse auf den gewünschten Winkel ein.

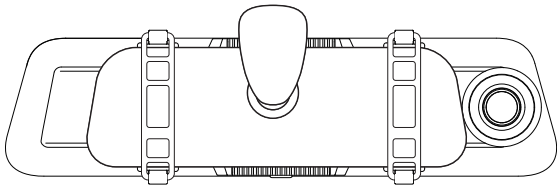

2. Schließen Sie das Kfz-Ladegerät an den Ladeadapter an, um die Dashcam mit Strom zu versorgen.

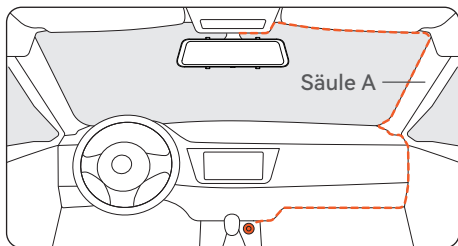

• Strom EIN/AUS

- DZum Einschalten drücken Sie kurz auf die Einschalttaste, zum Ausschalten drücken Sie lange auf die Einschalttaste.
- Wenn Sie das Autoladegerät verwenden und der Zigarettenanzünderstecker auf ACC steht, schaltet sich die Dashcam automatisch ein, wenn das Auto angeschlossen wird.

• Installation der Rückfahrkamera

Wenn Sie den Winkel nicht einstellen müssen, können Sie diese Eisenplatte entfernen.

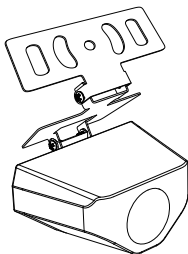
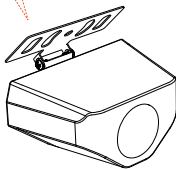

- Außerhalb der Fahrzeughalterung
- Innerhalb der Fahrzeughalterung

- Anleitung zur Verkabelung der Rückfahrkamera

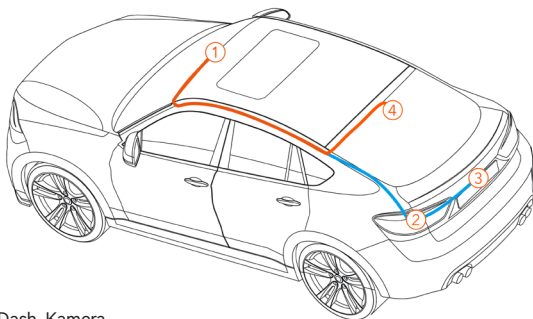

- ① Dash-Kamera
- ② Angeschlossen an den Rückfahrleuchteinsatz
- ③ Rückfahrleuchteinsatz Außerhalb der Fahrzeughalterung
- ④ Innenseite der Fahrzeughalterung

Anmerkung:

Für die Rückfahrkamera gibt es zwei Möglichkeiten der Kabelführung, die beide das Kabel entlang der Türkanten verbergen.

1. Verbinden Sie das Kabel der Rückfahrkamera mit dem Spiegel

Schließen Sie das Kabel der Rückfahrkamera an die AVSchnittstelle des Geräts an.

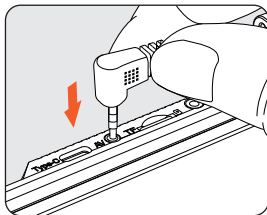

2. Kabelführung der Rückfahrkamera

Führen Sie das Kabel der Rückfahrkamera zum Heck des Fahrzeugs und lassen Sie dabei etwas Spielraum. Stecken Sie das Kabel mit dem mitgelieferten Werkzeug in den Spalt in der Frontscheibe und entlang des oberen Endes der Tür.

Wenn Sie sich dafür entscheiden, die Rückfahrkamera in Ihrem Auto zu installieren, befestigen Sie sie an der Heckscheibe, nachdem Sie die Kabel verlegt haben.

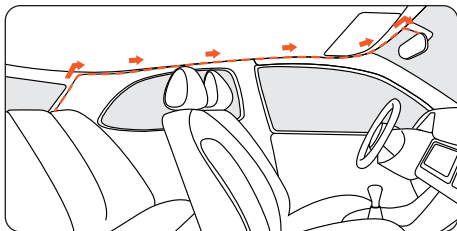

3. Entfernen Sie das Paneel

Öffnen Sie den Kofferraum und entfernen Sie die Innenverkleidung, die die andere Seite des Kennzeichenhalterungsbereichs abdeckt. Verwenden Sie ein Werkzeug zum Entfernen der Verkleidung oder eine andere dünne Vorrichtung, um die Verkleidung aufzuhebeln.

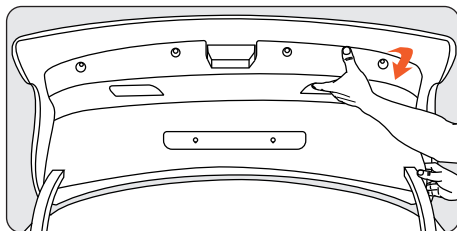

4. Befestigen Sie die Rückfahrkamera und schließen Sie die Kabel an

Befestigen Sie die Rückfahrkamera in der Nähe der Kennzeichenbeleuchtung mit Klebstoff, und schließen Sie das Rückfahrkamerakabel durch das Loch in der Kennzeichenbeleuchtung an das Rückfahrkamerakabel an.

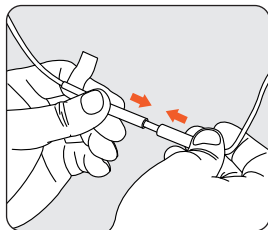
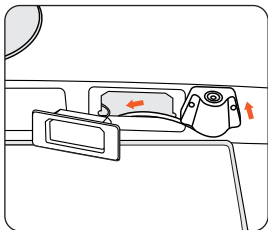

5. Schließen Sie das rote Kabel an den Pluspol des Rückfahrcheinwerfers an.

Suchen Sie den Pluspol des Rückfahrcheinwerfers. Dies ist der Anschluss, an dem Spannung anliegt, wenn das Fahrzeug den Rückwärtsgang einlegt. Um ihn zu finden, treten Sie auf die Bremse, legen Sie den Rückwärtsgang ein und messen Sie die Spannung an jeder Klemme. Die Klemme mit der Spannung ist die Plusklemme. Isolieren Sie das Pluskabel ab und umwickeln Sie es mit dem roten Kabel der Kamera. Isolieren Sie die Verbindung mit Isolierband. Testen Sie die Verbindung, indem Sie den Rückwärtsgang einlegen und prüfen, ob die Dashcam den Rückwärtsgang einlegt.

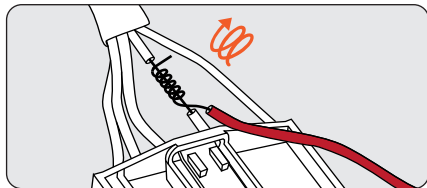

• GPS-Installation

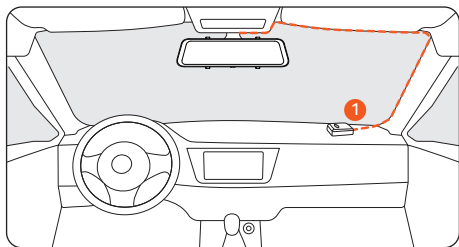

Position 1:

Installieren Sie die Dashcam in der rechten Ecke der Mittelkonsole und verbergen Sie die Verkabelung mit doppelseitigem Klebeband entlang der Kante der vorderen Windschutzscheibe.

- In Anbetracht des Nutzungseffekts und der Installationsfreundlichkeit empfehlen wir unseren Kunden in der Regel die Installation an position 1.
- Sie können auch verschiedene Standorte für die Dashcam ausprobieren, um denjenigen zu finden, der für Sie am besten geeignet ist. Achten Sie nur darauf, dass die schwarze Seite nach oben zeigt, um das GPS-Signal zu empfangen.
- Sobald das GPS installiert ist, wird das GPS-Symbol auf dem Startbildschirm angezeigt. Nachdem das GPS-Signal empfangen wurde, zeigt das GPS des Geräts Richtung und Geschwindigkeit an.



Fehlerbehebung

- **Kann die Wi-Fi-Funktion durch ein Upgrade der Firmware erhalten werden?**

Das G850 Wi-Fi ist ein Hardware-Upgrade von einer früheren Version, und seine Wi-Fi-Funktion kann nicht durch ein Firmware-Upgrade verfügbar gemacht werden.

- **Können Bilder der Rückfahrkamera drahtlos übertragen werden?**

Das G850 Wi-Fi wird mit einem Rückfahrkamera-Kabel geliefert, über das das Video der Rückfahrkamera übertragen wird. Die Wi-Fi-Funktion wird nur verwendet, um das Telefon mit der Dashcam zu verbinden.

- **Ist es möglich, das Fahrzeug über Wi-Fi auf dem G850 aus der Ferne zu überwachen?**

In Anbetracht der begrenzten Wi-Fi-Reichweite ist es nicht möglich, das Fahrzeug aus der Ferne über die mit dem G850 verbundene App zu überwachen.

- **Bild der Rückfahrkamera unscharf oder nicht erkannt?**

Bei "Unscharfes Bild von hinten" stellen Sie bitte sicher, dass die Schutzfolie auf dem Objektiv entfernt wurde und wischen Sie das Objektiv mit einem Reinigungsmittel ab. Wenn die Fokussierungsprobleme durch hohe Temperaturen verursacht werden, wenden Sie sich bitte an uns, damit wir Sie unterstützen können.

Wenn Sie die Fehlermeldung "Rückfahrkamera nicht erkannt" erhalten, überprüfen Sie den AV-Eingang auf der Oberseite des Spiegels und das Kabel der Rückfahrkamera auf Schäden, insbesondere am Stecker.

- **Wie kann ich das Gerät über Wi-Fi mit der App verbinden?**
 1. Bitte vergewissern Sie sich, dass Wi-Fi in den Einstellungen manuell aktiviert ist.
 2. Suchen Sie im App Store nach "WOLFBOX", um die neueste Version der App herunterzuladen.
 3. Überprüfen Sie die Wi-Fi-Liste auf Ihrem Smartphone, um zu sehen, ob das Netzwerk mit dem Namen "WOLFBOX" gefunden werden kann.
 4. Wenn die App "Verbindung fehlgeschlagen" anzeigt,finden Sie "Get Suppok" in der App, um uns zu kontaktieren.

Contenu

Produit Spécifications	47
Apparence	48
Interface Utilisateur Vue d'ensemble	49
Fonction Vue d'ensemble	57
Jouer sur APP (A Propos du Wi-Fi et de l'APP)	58
Comment Regarder une Vidéo sur un Ordinateur	59
Installation	61
Problème Résolution des Problèmes	67

Produit Spécifications

RAM	DDR3 2Gb	Type d'affichage	IPS
Format vidéo	MP4	Format de l'image	JPG
Caméra frontale	4K	Caméra arrière	1080P
Taille de l'affichage	12"	Objectif arrière FPS	25fps
Interface d'alimentation	USB-C	GPS	Externe, Interface pour casque d'écoute de 3,5 mm
Connexion Wi-Fi	Supporté	Contrôle vocal	Supporté
Température de fonctionnement	-4° F ~158° F	Écran tactile complet	Supporté
Carte SD	Capacité maximale de 512 Go		

Apparence

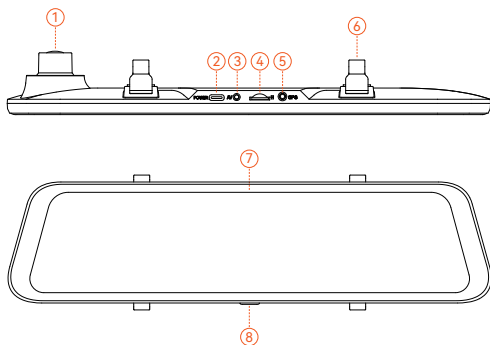



NON.	Nom	Description
1	Lentille	L'objectif avant, qui enregistre la vue avant de la voiture
2	Pok USB-C	Pok pour l'alimentation électrique/la connexion
3	Connecteur de la caméra arrière	Port utilisé pour connecter la caméra arrière
4	Fente pour carte TF	Offre un espace de stockage extensible (Class 10,capacité maximale de 256 Go)
5	Connecteur GPS	Utilisé pour connecter le module GPS (La fonction GPS nécessite une antenne GPS en option)
6	Fixations	La machine peut être maintenue en position à l'aide de deux sangles.
7	Écran d'affichage	Écran tactile de 12 pouces
8	Bouton d'alimentation	Une pression courte permet de se réveiller/ de dormir,une pression longue d'allumer/de s'éteindre

Interface Utilisateur Vue d'ensemble





Icône	Description
	Vitesse et direction : Une fois le GPS connecté, les informations suivantes s'affichent
	Date et heure
	Activation/désactivation du son de l'appareil
	Activation/désactivation du Wi-Fi
	Afficher les entrées de commandes vocales
	Activation/désactivation de l'enregistrement
	Régler de la luminosité de l'écran
	Basculer entre vue de caméra avant, arrière et écran partagé
	Capture rapide : faire une capture rapide
	État d'enregistrement : clignotement jaune indiquant l'enregistrement verrouillé

Icône	Description
	Lecture des fichiers : Lecture des vidéos et des photos
	Activation/désactivation de l'enregistrement audio
	Paramètres : Appuyez pour ouvrir le menu des paramètres

• Mode de lecture







Lorsque vous allumez la dashcam, elle commence automatiquement à enregistrer. Cliquez sur  pour accéder au mode de lecture.



	Enregistre les images de la caméra avant		Enregistre les images de la caméra de recul
	Vidéo normale : Sélectionnez-la pour afficher les vidéos enregistrées		Vidéo verrouillée : Sélectionnez-la pour consulter les vidéos verrouillées
	Photos : Sélectionnez-la pour consulter les photos		Sélectionner
	Supprimer		Pour verrouiller la vidéo
	Regarder les vidéos en mode plein écran		

Aperçu des Fonctions

Cliquez sur l'icône des paramètres pour ouvrir le menu des fonctions, où vous pouvez régler diverses fonctions et paramètres de l'appareil.



Fonction	Option	Description
 Résolution	4K30fps+1080P25fps/ 2.5K30fps+1080P25fps/ 1080P30fps+1080P25fps	Choix de la résolution vidéo.
 Modes d'affichage	Caméra frontale/Caméra arrière/Écran partagé	Définissez l'écran d'affichage par défaut pour l'enregistrement vidéo au démarrage.
 Enregistrement sonore	Désactivé/Activé	Déterminez si le son doit être enregistré.
 Durée de l'enregistrement	1 Minute/2 Minutes /3 Minutes	Réglez la durée de l'enregistrement en boucle.
 Sensibilité aux collisions	Désactivé/Faible/ Moyenne/Haute	Après détection d'une collision, l'appareil verrouille la vidéo enregistrée.
 Rappel de fatigue	Désactivé/1 Hour/2 Hours/3 Hours	Réglez le temps pour l'alerte de fatigue.

Fonction	Option	Description
 Wi-Fi	Désactivé/Activé	Réglez l'heure d'activation du veilleur d'écran.
 Volume	Désactivé/Faible/Moyenne/Haute	Réglez le volume.
 Tonalité de bouton	Désactivé/Activé	Réglez l'option pour les sons de touches.
 Protection d'écran	Désactivé/10 secondes/30 secondes/2 minutes	Réglez le statut de la connexion Wi-Fi de l'appareil.
 Luminosité de l'écran	/	Réglez la luminosité de l'écran.
 Exposition	/	Réglez le contraste de la caméra avant.
 Contrôle vocal	Désactivé/Activé/Commande vocale	Réglez l'option pour la fonction de commande vocale.

Fonction	Option	Description
 <p>Mise en miroir de la caméra arrière</p>	Désactivé/Activé	Réglez l'inversion gauche-droite de l'image de la caméra de recul.
 <p>Retournement de la came arrière</p>	Désactivé/Activé	Réglez l'inversion haut-bas de l'image de la caméra arrière.
 <p>Mode de ligne d'inversion</p>	Désactivé/Activé	Réglez l'option pour l'affichage des lignes de recul.
 <p>Surveillance de stationnement Désactivé/ G-Déclencher</p>	l'enregistrement/ Enregistrement en accéléré 12 h/ Enregistrement en accéléré 24 h/ Enregistrement en accéléré 48h	Surveillez l'état du véhicule après avoir éteint le moteur.
 <p>GPS</p>	/	Affichez les données GPS enregistrées.
 <p>Affichage GPS</p>	Désactivé/Activé	Réglez si les informations GPS doivent être affichées sur l'interface d'enregistrement.

Fonction	Option	Description
 Filigrane temporel	Désactivé/Activé	Réglez l'option pour le filigrane de date.
 Filigrane de vitesse	Désactivé/Activé	Réglez l'option pour le filigrane de vitesse.
 Filigrane de GPS	Désactivé/Activé	Réglez l'option pour le filigrane de GPS.
 Unités de vitesse	KM/H / MPH	Réglez l'unité d'affichage de la vitesse.
 Langue	English/Français/ Deutsch/Italiano/ Español/...	Réglez la langue de l'appareil.
 Réglage de l'horloge	/	Réglez l'heure actuelle de l'appareil.
 Format de l'heure	YY-MM-DD /DD-MM-YY /MM-DD-YY	Réglez le format d'affichage de l'heure.

Fonction	Option	Description
 Style temporel	12 heures/24 heures	Réglez le système d'affichage de l'heure.
 Fuseau horaire	/	Réglez le fuseau horaire en fonction de la position géographique.
 Heure d'été	Désactivé/Activé	Réglez le passage à l'heure d'été.
 Fréquence stroboscopique	50 Hz/60 Hz	Informations de contact du service client.
 Centre d'aide	/	Réglez le rappel pour la formatation de la carte SD.
 Rappel de format	Désactivé/Tous les 15 jours/Tous les 25 jours	Réglez le rappel pour la formatation de la carte SD.
 Formater la carte SD	/	Formatez la carte SD et supprimez les vidéos et photos enregistrées.

Fonction	Option	Description
 réinitialiser la configuration	/	Réinitialisez tous les paramètres aux valeurs d'usine.
 APP	/	Fournissez un QR code pour télécharger l'application.
 Informations sur le produit	/	Affichez les informations sur l'appareil.

Remarque:

Le mode parking nécessite un kit matériel (acheté séparément) pour être activé.

Lorsque le kit matériel est connecté et que le mode parking est activé, la dashcam passe en mode Lapse Recording lorsque la voiture s'éteint. Ce mode enregistre des vidéos à raison d'une image par seconde jusqu'à la fin de la durée définie ou jusqu'à ce que la tension de la batterie de la voiture descende en dessous de 12V.

Fonction de Commande Vocale

Contrôle rapide via commandes vocales simples

Lorsque le symbole  est blanc, cela signifie que la fonction peut être utilisée normalement.

Vous pouvez activer/désactiver la fonction de commande vocale via "Commande vocale" dans le menu.

lock the video	
take picture	
turn on audio	turn off audio
turn on screen	turn off screen
turn on Wi-Fi	turn off Wi-Fi
turn on recording	turn off recording
show front camera	show rear camera

Remarque :

Vous avez deux façons de consulter les commandes vocales spécifiques:

- 1 Appuyez sur le symbole de commande vocale  dans l'interface de capture.
- 2 Appuyez sur le sous-menu "Contrôle vocal" sous la fonction "Commande vocale".

Jouer sur APP (A Propos du Wi-Fi et de l'APP)

La fonction Wi-Fi a été conçue pour que vous puissiez coupler votre caméra sans fil avec votre smartphone et accéder instantanément à vos enregistrements depuis la caméra. Vous pouvez ainsi visionner, télécharger et partager facilement vos vidéos avec vos amis et votre famille.

L'application "WOLFBOX" est une application gratuite qui vous permet de faire fonctionner cet enregistreur de conduite intégré WLAN à partir de votre smartphone.

• Comment se connecter au Wi-Fi?

1. Télécharger l'application "Wolfbox"

Rendez-vous à l'adresse suivante pour télécharger l'application "WOLFBOX" : <https://wolfbox.com/app/> Vous pouvez également utiliser votre smartphone pour scanner le code QR afin d'accéder à la page de téléchargement.



2. Activer le Wi-Fi

Allez dans Paramètres pour activer le Wi-Fi. Allez dans Paramètres pour activer le Wi-Fi. L'écran de l'appareil affiche alors le nom et le mot de passe Wi-Fi.

3. Connecter le Wi-Fi

Pour connecter votre iPhone ou votre téléphone Android au réseau Wi-Fi du G850, allez dans Réglages > Wi-Fi et sélectionnez G850 Wi-Fi. Saisissez ensuite le mot de passe par défaut : 12345678.

4. Ouvrir l'application "Wolfbox"

Une fois que votre téléphone portable est connecté à la connexion Wi-Fi, ouvrez l'application WOLFBOX. La caméra se synchronisera automatiquement et vous devriez voir le flux vidéo en direct sur votre téléphone.

• Modifiez et partagez vos vidéos dans l'application

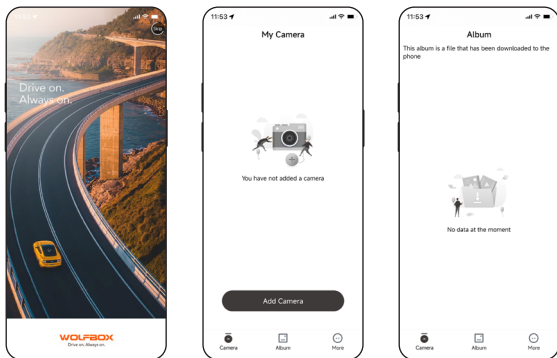

Dans l'application, vous pouvez afficher et modifier les albums locaux téléchargés et les partager avec d'autres personnes.

Comment Regarder une Vidéo sur un Ordinateur

Nous recommandons l'application "GPS Media Player" pour regarder et lire les vidéos de la caméra embarquée et afficher les cartes Google.

Vous pouvez le télécharger gratuitement sur Mac ou Windows à partir du lien suivant: <https://wolfbox.com/gps-player/>

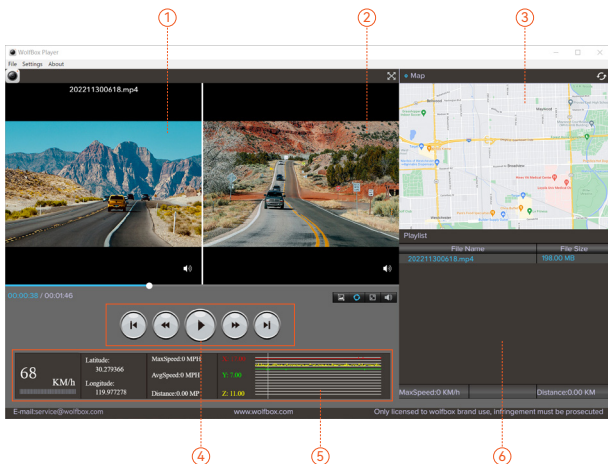

- ① Fenêtre de lecture vidéo (avant) ② Fenêtre de lecture vidéo (arrière)
- ③ Affichage de la carte et des pistes ④ Panneau de contrôle de lecture
- ⑤ Indication de la vitesse et de l'état de conduite ⑥ Liste de lecture

Remarque:

Si vous enregistrez simultanément les vidéos des caméras avant et arrière et que vous les ajoutez à la liste de lecture, vous pouvez les lire côte à côte en mode écran partagé.

Pour lire un fichier vidéo, faites-le glisser et déposez-le sur le lecteur vidéo.

Installation

Assurez-vous que le dash cam est éteint lorsque vous insérez ou éjectez la carte SD.

• Installation de la carte SD

Assurez-vous que la dashcam est hors tension lorsque vous insérez ou éjectez la carte SD.

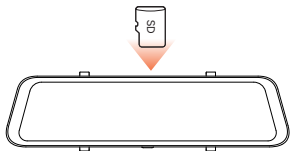

• Vue de face de l'hôte

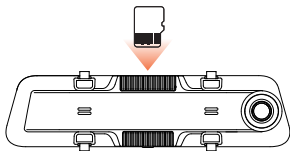

• Vue arrière de l'hôte

• Installation de l'unité

1. Placez l'unité principale (WOLFBOX Mirror) sur le rétroviseur à la main, en veillant à séparer les supports en silicone des deux côtés du rétroviseur. Fixez l'appareil au rétroviseur à l'aide des sangles en caoutchouc. Réglez la lentille frontale à l'angle souhaité.

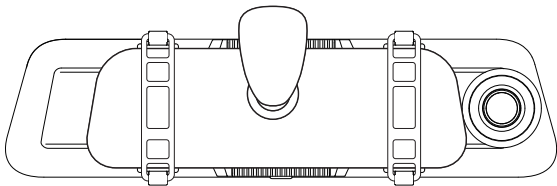

2. Connectez le chargeur de voiture à l'adaptateur de chargeur pour alimenter la caméra embarquée.

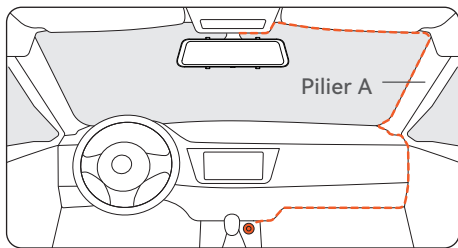

• Alimentation ON/OFF

- Appuyez brièvement sur le bouton d'alimentation pour allumer l'appareil, appuyez longuement sur le bouton d'alimentation pour l'éteindre.
- Lors de l'utilisation du chargeur de voiture, si l'allume-cigare est ACC, la dashcam s'allume automatiquement lorsque la voiture est branchée.

• Installation de la caméra arrière

Si vous n'avez pas besoin de régler l'angle, vous pouvez retirer cette plaque de fer.

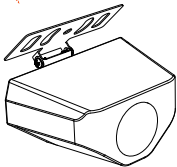

• A l'extérieur du support de la voiture

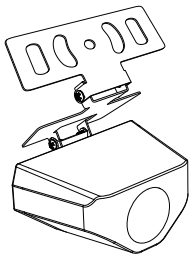

• Intérieur du support de la voiture

• Instructions de câblage de la caméra arrière

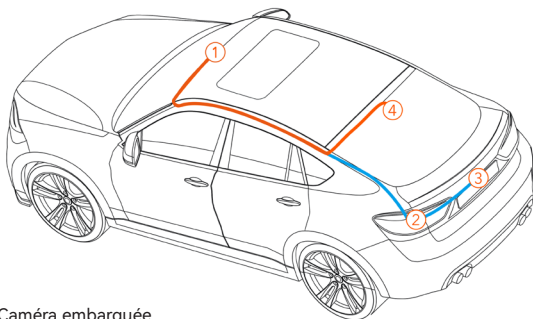

① Caméra embarquée

② Connecté au feu de recul A

③ l'extérieur du support de la voiture

④ A l'intérieur du support de la voiture

Remarque :

La caméra arrière dispose de deux options d'acheminement du fil, qui dissimulent toutes deux le fil le long des bords de la porte.

1. Connecter le câble de la caméra arrière au miroir

Branchez le câble de la caméra arrière dans l'interface AV de l'appareil.

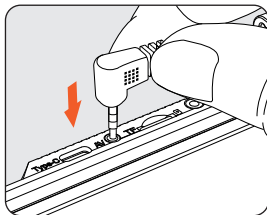

2. Acheminement du câble de la caméra arrière

Acheminez le câble de la caméra arrière vers l'arrière de la voiture, en laissant du mou. Insérez le câble dans l'espace du pare-brise avant et le long de l'extrémité supérieure de la porte à l'aide de l'outil fourni.

Si vous choisissez d'installer la caméra arrière à l'intérieur de votre voiture, fixez-la sur le pare-brise arrière après avoir acheminé le câblage.

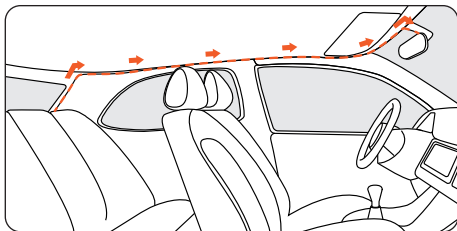

3. Retirer le panneau

Ouvrez le coffre et retirez le panneau intérieur qui recouvre l'autre côté de la zone de fixation de la plaque d'immatriculation. Utilisez un outil de dépose de garniture ou un autre dispositif fin pour ouvrir le panneau en faisant levier.

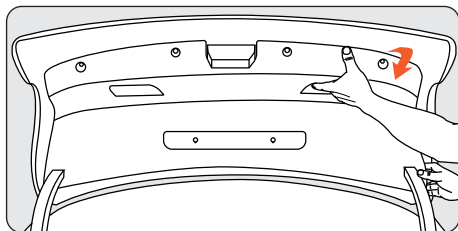

4. Fixer la caméra arrière et connecter les câbles

Fixez la caméra arrière près de l'éclairage de la plaque d'immatriculation avec de l'Adhésif, et connectez le câble de la caméra arrière à travers le trou de l'éclairage de la plaque d'immatriculation.

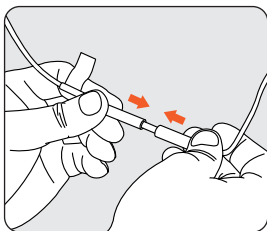
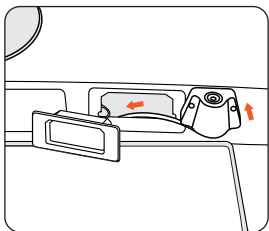

5. Connecter le fil rouge à la borne positive du feu de recul.

Trouvez la borne positive du feu de recul. C'est la borne qui est sous tension lorsque la voiture est en marche arrière. Pour la trouver, appuyez sur les freins, passez la marche arrière et mesurez la tension à chaque borne. La borne sous tension est la borne positive. Dénudez le câble positif et enroulez-le avec le câble rouge de l'appareil photo. Isolez la connexion avec duruban adhésif. Testez la connexion en mettant la voiture en marche arrière et en vérifiant si la caméra du tableau de bord passe en mode marche arrière.

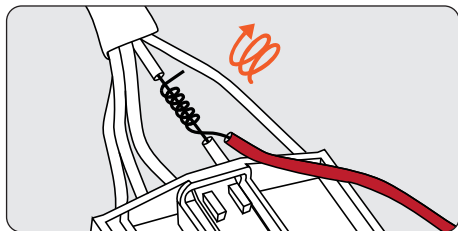

• Installation du GPS

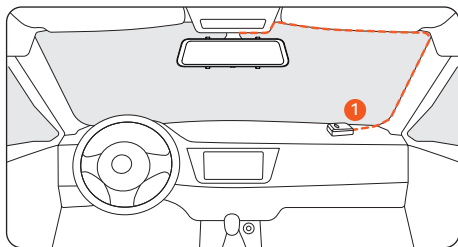

Position 1:

Installez la caméra de tableau de bord dans le coin droit de la console centrale et cachez le câblage le long du bord du parebrise avant à l'aide d'un ruban adhésif double face.

- Compte tenu de l'effet d'utilisation et de la facilité d'installation, nous recommandons généralement aux clients de l'installer en position en position 1.
- Vous pouvez également tester différents emplacements pour la caméra de bord afin de trouver celui qui vous convient le mieux. Veillez simplement à ce que le côté noir soit orienté vers le haut pour recevoir le signal GPS. Une fois le GPS installé, l'icône GPS apparaît sur l'écran d'accueil.
- Une fois le GPS installé, l'icône GPS apparaît sur l'écran d'accueil. Une fois le signal GPS reçu, le GPS de l'appareil indique la direction et la vitesse.



Problème Résolution des Problèmes

- **La fonction Wi-Fi peut-elle être obtenue en mettant à jour le micrologiciel ?**

Le G850 Wi-Fi est une mise à niveau matérielle d'une version précédente, et sa fonction Wi-Fi ne peut pas être disponible par le biais d'une mise à niveau du micrologiciel.

- **Les images de la caméra arrière peuvent-elles être transmises sans fil ?**

Le G850 Wi-Fi est livré avec un câble de caméra arrière par lequel la vidéo de la caméra arrière est transmise. La fonction Wi-Fi n'est utilisée que pour connecter le téléphone à la caméra de bord.

- **Est-il possible de surveiller le véhicule à distance via le Wi-Fi Sur le G850?**

Compte tenu de la portée limitée du Wi-Fi, il n'est pas possible de surveiller le véhicule à distance via l'application connectée au G850.

- **L'image de la caméra arrière est floue ou n'est pas détectée?**

Pour le problème de "l'image arrière floue", assurez-vous que le film protecteur de l'objectif est retiré et essuyez l'objectif avec un produit nettoyant. Si les problèmes de mise au point sont causés par des températures élevées, veuillez nous contacter pour obtenir de l'aide.

Si vous obtenez une erreur "Caméra arrière non détectée", vérifiez que l'entrée AV sur le dessus du rétroviseur et le câble de la caméra arrière ne sont pas endommagés, en particulier au niveau du connecteur.

- **Comment connecter l'appareil à l'application via le Wi-Fi?**

1. Assurez-vous que le Wi-Fi est activé manuellement dans les paramètres.
2. Recherchez "WOLFBOX" dans l'app store pour télécharger la dernière version de l'application.
3. Vérifiez la liste des réseaux Wi-Fi sur votre téléphone portable pour voir si le réseau nommé "WOLFBOX" peut être trouvé.
4. Si l'application affiche "Connection Failed", veuillez trouver "Get Suppok" dans l'application pour nous contacter.

Contenuto

Specifiche del Prodotto	69
Aspetto	70
Panoramica dell'Interfaccia Utente.	71
Panoramica delle Funzioni	73
Utilizza l'APP (Wi-Fi e APP Informazioni)	80
Come Guardare un Video su un Computer	81
Installazione	83
Risoluzione dei Problemi	89

Specifiche del Prodotto

RAM	DDR3 2Gb	Tipo Schermo	IPS
Formato Video	MP4	Formato Immagine	JPG
Camera Anteriore	4K	Camera Posteriore	1080P
Schermo	12"	FPS Posteriore	25 fps
Interfaccia Alimentatore	USB-C	GPS	Esterno, interfaccia cuffie da 3,5 mm
Connessione Wi-Fi	Supportato	Controllo Vocale	Supportato
Temperatura di Funzionamento	-4°F ~ 158°F	Schermo Tattile Completo	Supportato
Scheda SD	supporto massimo 512 GB		

Aspetto

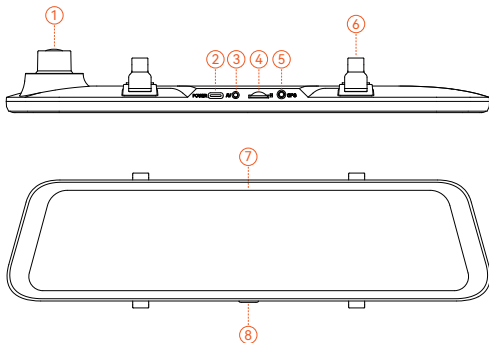



NO.	Nome	Descrizione
1	Obiettivo	Obiettivo frontale, registra la vista frontale
2	Porta USB-C	Porta per l'alimentazione/connesione
3	Connettore fotocamera posteriore	Porta utilizzata per collegare la fotocamera posterior
4	Slot per scheda TF	Fornisce spazio di archiviazione espandibile (classe 10 Max 256GB)
5	Connettore GPS	Utilizzato per collegare il modulo GPS (la funzione GPS richiede un'antenna GPS opzionale)
6	Elementi di fissaggio	La macchina può essere tenuta in posizione con 2 cinghie
7	Schermo	Display touch screen da 12" pollici
8	Pulsante di accensione	Premere brevemente per svegliare/sospendere, premere a lungo per accendere/spengere il dispositivo.

Panoramica dell'Interfaccia Utente











Icone	Descrizione
	Velocità e direzione di guida: Una volta collegato il GPS, vengono visualizzate le informazioni corrette.
	Data e ora
	Attiva/Disattiva il suono del dispositivo
	Attiva/Disattiva il Wi-Fi
	Visualizza le voci dei comandi vocali
	Avvio/arresto della registrazione
	Regolare la luminosità dello schermo
	Commutazione tra vista anteriore, posteriore e split-screen della camera
	Istantanea: Scatta un'istantanea
	Stato registrazione: Il giallo lampeggiante indica il blocco della registrazione (il video registrato non verrà sovrascritto).

Icone	Descrizione
	Riproduzione file: Riproduzione di video e foto
	Attivare/disattivare la registrazione audio
	Impostazioni: Toccare per accedere al menu delle impostazioni

• Modalità di riproduzione







Quando si accende la dash cam, inizia a registrare automaticamente. Fare clic/selezionare  per accedere alla modalità di riproduzione.















	Memorizza immagini catturate dalla fotocamera anteriore Stores images captured by the rear camera		Memorizza immagini catturate dalla fotocamera posteriore Normal Video: Select it to view recorded videos
	Video Normali: Selezionalo per visualizzare i video registrati Locked Video: Select it to check locked videos		Video Bloccati: Selezionalo per controllare i video bloccati Photos: Select it to check photos
	Foto: Selezionalo per controllare le foto		Seleziona
	Elimina		Blocca il video
	Visualizza i video a schermo intero		







Panoramica delle Funzioni







Fare clic sull'icona di impostazione per accedere al menu delle funzioni, dove è possibile regolare varie funzioni e parametri dell'intera macchina.



Funzione	Opzione	Descrizione
 Risoluzione	4K30fps+1080P25fps/ 2.5K30fps+1080P25fps/ 1080P30fps+1080P25fps	Scelta della risoluzione video.
 Modalità visual	Cam Front/Cam Post/ Split-screen	Impostare la schermata di visualizzazione standard all'avvio per la registrazione video.
 Audio	Apri/Chiudi	Impostare se registrare l'audio.
 Durata	1 min/2 min/3 min	Impostare la durata della registrazione ciclica.
 Sensibilità impatti	Chiudi/Basso/Medio/ Alto	Dopo il rilevamento di una collisione/urto, il dispositivo blocca il video registrato.
 Allerta stanchezza	Chiudi/1 Ora/2 Ore/3 Ore	Impostare il tempo per l'avviso di stanchezza.

Funzione	Opzione	Descrizione
 Wi-Fi	Apri/Chiudi	Impostare il tempo di attivazione del salvaschermo.
 Volume	Chiudi/Basso/Medio/Alto	Impostare il volume.
 Tasti	Apri/Chiudi	Impostare l'opzione per i toni di tastiera.
 Salvaschermo	Chiudi/10 secondi/30 secondi/2 minuti	Impostare lo stato della connessione Wi-Fi del dispositivo.
 Luminosità	/	Impostare la luminosità dello schermo.
 Esposizione	/	Impostare il contrasto della fotocamera anteriore.
 Controllo vocale	Apri/Chiudi/Comandi vocali	Impostare l'opzione per la funzione di controllo vocale.

Funzione	Opzione	Descrizione
 <p>Specchio retrocamera</p>	Apri/Chiudi	Impostare l'inversione sinistra-destra dell'immagine della retrocamera.
 <p>Inversione retrocamera</p>	Apri/Chiudi	Impostare l'inversione alto-basso dell'immagine della retrocamera.
 <p>Linee retromarcia</p>	Apri/Chiudi	Impostare l'opzione per la funzione di visualizzazione delle linee di retromarcia.
 <p>Monitoraggio parcheggio</p>	Chiudi/Registrazione G/Timelapse 12 ore/ Timelapse 24 ore/ Timelapse 48 ore	Monitorare lo stato del veicolo dopo aver spento il motore.
 <p>GPS</p>	/	Visualizzare i dati GPS registrati.
 <p>Visualizzazione GPS</p>	Apri/Chiudi	Impostare se visualizzare le informazioni GPS sulla schermata di registrazione.

Funzione	Opzione	Descrizione
 Watermark orario	Apri/Chiudi	Attivare l'opzione per il timestamp della data.
 Watermark velocità	Apri/Chiudi	Attivare l'opzione per il timestamp della velocità.
 Watermark GPS	Apri/Chiudi	Attivare l'opzione per il timestamp GPS.
 Unità velocità	KM/H / MPH	Impostare l'unità per la visualizzazione della velocità.
 Lingua	English/Français/ Deutsch/Italiano/ Español/...	Impostare la lingua per il dispositivo.
 Impostazione orologio	/	Impostare l'ora attuale sul dispositivo.
 Formato ora	YY-MM-DD /DD-MM-YY /MM-DD-YY	Impostare il formato di visualizzazione della data.

Funzione	Opzione	Descrizione
 Formato orario	12 ore/24 ore	Impostare il sistema di visualizzazione dell'ora.
 Fuso orario	/	Impostare il fuso orario in base alla posizione geografica.
 Ora legale	Apri/Chiudi	Attivare/Disattivare la conversione per l'ora legale.
 Frequenza flicker	50 Hz/60 Hz	Informazioni di contatto per il servizio clienti.
 Centro assistenza	/	Impostare il promemoria per la formattazione della scheda SD.
 Promemoria formattazione	Chiudi/Ogni 15 giorni/Ogni 25 giorni	Impostare la frequenza del promemoria per la formattazione della scheda SD.
 Formattazione SD	/	Formattare la scheda SD e cancellare i video e le foto salvati su di essa.

Funzione	Opzione	Descrizione
 Prova velocità	/	Ripristinare tutte le impostazioni alle impostazioni di fabbrica.
 APP	/	Fornire un codice QR per scaricare l'app.
 Informazioni prodotto	/	Visualizzare le informazioni sul dispositivo.

Nota:

La modalità di parcheggio richiede un kit hardware (acquistato separatamente) per essere attivata.

Con il kit hardware collegato e la modalità di parcheggio attivata, la dash cam entra in modalità di registrazione ritardata quando l'auto si spegne. Questa modalità cattura video a 1 fotogramma al secondo fino al termine della durata impostata o fino a quando la tensione della batteria dell'auto non scende al di sotto dei 12V.

Funzione di controllo vocale

Controllo rapido tramite semplici comandi vocali

Quando l'icona  è bianca, significa che la funzione può essere utilizzata normalmente.

Puoi attivare/disattivare la funzione di controllo vocale dal menu "Controllo vocale".

lock the video	
take picture	
turn on audio	turn off audio
turn on screen	turn off screen
turn on Wi-Fi	turn off Wi-Fi
turn on recording	turn off recording
show front camera	show rear camera

Nota:

Hai due modi per visualizzare i comandi vocali specifici:

- 1 Tocca l'icona del controllo vocale  nella schermata di registrazione.
- 2 Tocca il sottomenu "Comando vocale" sotto la funzione "Controllo vocale".

Utilizza l'APP (Wi-Fi e APP Informazioni)

La funzione Wi-Fi è stata progettata per consentirti di connettere la tua videocamera per cruscotto in modalità wireless al tuo smartphone, permettendoti di accedere istantaneamente alle registrazioni. Da qui, puoi visualizzare, scaricare e condividere facilmente i tuoi video con amici e familiari.

L'app "WOLFBOX" è gratuita e ti permette di controllare questo registratore di guida con WLAN integrata direttamente dal tuo smartphone.

• Come connettersi al Wi-Fi?

1. Scarica l'app "WOLFBOX"

Visita il seguente indirizzo per scaricare l'app "WOLFBOX": <https://wolfbox.com/app/>.

Puoi anche scansionare il codice QR con il tuo smartphone per accedere alla pagina di download.



2. Abilita il Wi-Fi

Vai alle Impostazioni del tuo dispositivo e attiva il Wi-Fi. Successivamente, sullo schermo del dispositivo verranno visualizzati il nome della rete Wi-Fi e la password.

3. Connetti il Wi-Fi

Per collegare il tuo iPhone o telefono Android alla rete Wi-Fi del G850, vai a Impostazioni > Wi-Fi, seleziona la rete "G850 Wi-Fi" e inserisci la password predefinita: 12345678.

4. Apri l'app "WOLFBOX"

Una volta che il tuo telefono cellulare è connesso alla rete Wi-Fi del G850, apri l'app WOLFBOX. La fotocamera si sincronizzerà automaticamente e potrai vedere il feed video in diretta sul tuo telefono.

• Modifica e condividi i tuoi video nell'App

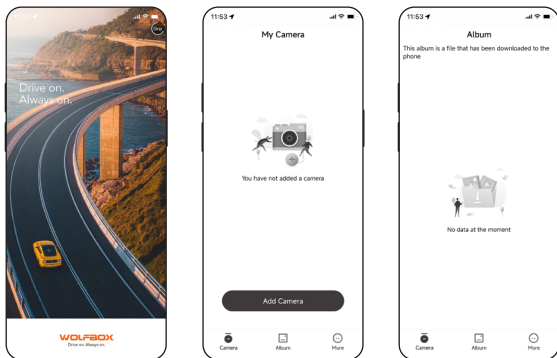

Nell'app, puoi visualizzare e modificare album locali scaricati e condividerli con altri.

Come guardare un video su un computer

Si consiglia l'applicazione "GPS Media Player" per guardare e riprodurre i video della dash cam e visualizzare Google Maps.

È possibile scaricarla gratuitamente su Mac o Windows dal seguente link: <https://wolfbox.com/gps-player/>

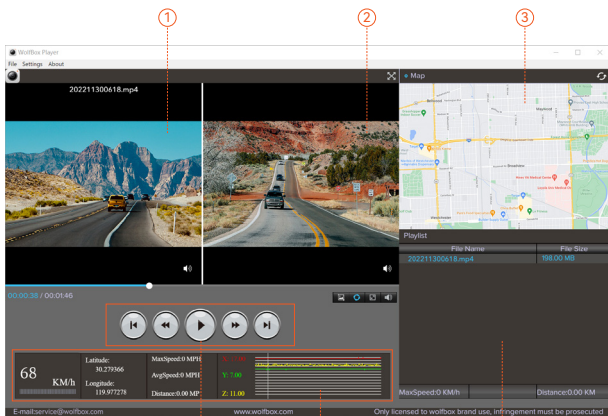

- ① Finestra di riproduzione video (anteriore)
- ② Finestra di riproduzione video (posteriore)
- ③ Visualizzazione di mappe e tracce
- ④ Pannello di controllo della riproduzione
- ⑤ Indicazione della velocità e dello stato di guida
- ⑥ Elenco di riproduzione

Nota:

Se si registrano contemporaneamente i video della dash cam anteriore e posteriore e li si aggiunge alla playlist, è possibile riprodurli affiancati in modalità split-screen.

Per riprodurre un file video, trascinarlo sul lettore video.

Installazione

Prima di installare la dash cam, verificarne il funzionamento con tutti gli accessori e modificare le impostazioni predefinite in base alle proprie preferenze

• Installazione della scheda SD

Assicurarsi che la dash cam sia spenta quando si inserisce o si estrae la scheda SD.

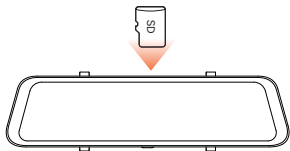

• The Front view of the host

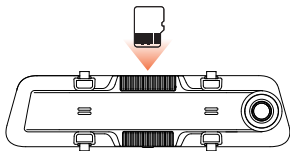

• The Back view of the host

• Installazione dell'unità

1. Posizionare l'unità principale (Wolfbox Mirror) sullo specchietto retrovisore a mano, assicurandosi di separare le staffe in silicone su entrambi i lati dello specchietto retrovisore. Fissare il dispositivo allo specchietto retrovisore con le cinghie di gomma. Regolare la lente anteriore all'angolazione desiderata.

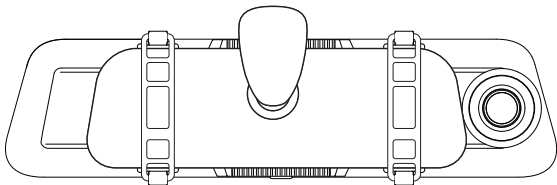

• Istruzioni per il cablaggio della camera posteriore

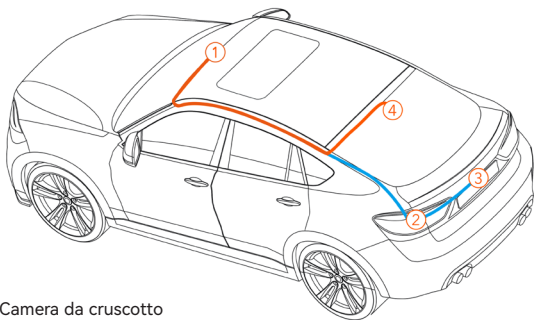

- ① Camera da cruscotto
- ② Collegata alla luce di retromarcia
- ③ All'esterno della staffa dell'auto
- ④ All'interno della staffa dell'auto

Nota:

La camera posteriore dispone di due opzioni di instradamento dei fili, entrambe in grado di nasconderli lungo i bordi della portiera.

1. Collegare il cavo della camera posteriore allo specchietto

Collegare il cavo della camera posteriore all'interfaccia AV dell'unità.

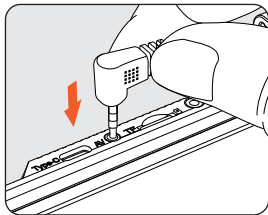

2. Passaggio del cavo della camera posteriore

Far passare il cavo della camera posteriore verso la parte posteriore dell'auto, lasciando un po' di margine. Inserire il cavo nella fessura del parabrezza anteriore e lungo l'estremità superiore della portiera utilizzando l'attrezzo in dotazione.

Se si sceglie di installare la camera posteriore all'interno dell'auto, fissarla sul parabrezza posteriore dopo aver instradato il cablaggio.

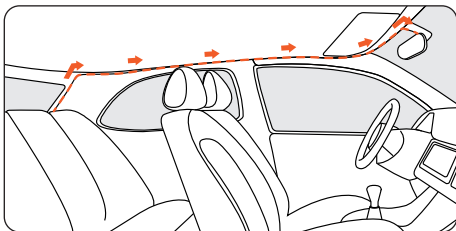

3. Rimuovere il pannello

Aprire il bagagliaio e rimuovere il pannello interno che copre l'altro lato dell'area di montaggio della targa. Utilizzare un attrezzo per la rimozione delle finiture o un altro dispositivo sottile per fare leva sul pannello.

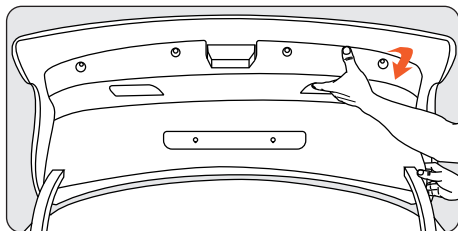

4. Fissare la camera posteriore e collegare i cavi

Fissare la camera posteriore vicino alla luce della targa con la colla e collegare il cavo della camera posteriore attraverso il foro della luce della targa al cavo della camera posteriore.

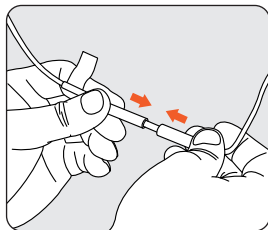
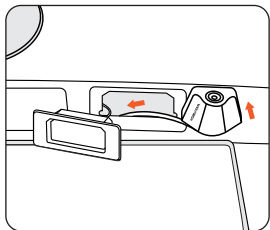

5. Collegare il filo rosso al terminale positivo della luce di retromarcia

Individuare il terminale positivo della luce di retromarcia. Si tratta del terminale che riceve tensione quando l'auto è in retromarcia. Per trovarlo, premere i freni, inserire la retromarcia e misurare la tensione su ciascun terminale. Il terminale con tensione è il terminale positivo. Spellare il cavo positivo e avvolgerlo con il cavo rosso della camera. Isolare il collegamento con nastro isolante. Testare il collegamento mettendo l'auto in retromarcia e verificando se la dash cam entra in modalità retromarcia.

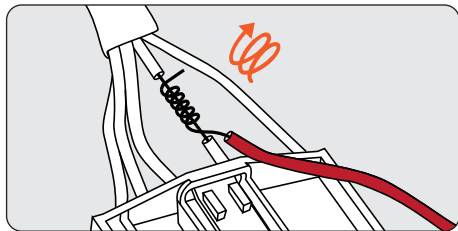

• GPS Installation

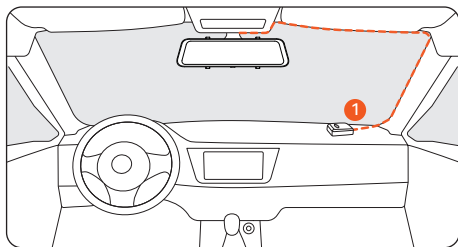

Posizione 1:

Installare la dash cam nell'angolo destro della console centrale e nascondere il cablaggio lungo il bordo del parabrezza anteriore utilizzando il nastro biadesivo.

- Considerando l'effetto d'uso e la convenienza dell'installazione, di solito consigliamo ai clienti di installarla nella **posizione 1**.
- È anche possibile testare diverse posizioni per la dash cam per trovare quella che funziona meglio per voi. Assicurarsi che il lato nero sia rivolto verso l'alto per ricevere il segnale GPS.
- Una volta installato il GPS, apparirà l'icona GPS nella schermata iniziale. Una volta ricevuto il segnale GPS, il GPS del dispositivo mostrerà la direzione e la velocità.



Risoluzione dei Problemi

- **Posso ottenere la funzionalità Wi-Fi aggiornando il firmware?**

La versione Wi-Fi del G850 rappresenta un aggiornamento hardware rispetto alla versione precedente, pertanto la sua funzionalità Wi-Fi non può essere ottenuta attraverso un semplice aggiornamento del firmware.

- **È possibile monitorare il veicolo in remoto tramite Wi-Fi sul G850?**

A causa della portata limitata del Wi-Fi, non è possibile monitorare il veicolo in remoto utilizzando l'App connessa al G850.

- **Le immagini della fotocamera posteriore possono essere trasmesse in modalità wireless?**

Il G850 Wi-Fi è dotato di un cavo per la fotocamera posteriore attraverso il quale viene trasmesso il segnale video. La funzionalità Wi-Fi è utilizzata esclusivamente per connettere il dispositivo al telefono e alla dash cam.

- **Immagine della fotocamera posteriore sfocata o non rilevata?**

In caso di "Immagine posteriore sfocata", si prega di assicurarsi che la pellicola protettiva sull'obiettivo sia stata rimossa e di pulire l'obiettivo con un detergente adatto. Se i problemi di messa a fuoco sono dovuti a alte temperature, si prega di contattarci per ricevere assistenza.

Se si riceve l'errore "Fotocamera posteriore non rilevata", controllare l'ingresso AV sulla parte superiore dello specchio e il cavo della fotocamera posteriore per eventuali danni, in particolare al connettore.

- **Come connettere l'unità all'App tramite Wi-Fi?**

1. Assicurarsi che il Wi-Fi sia attivato manualmente nelle impostazioni del dispositivo.

2. Cercare "WOLFBOX" nell'App Store per scaricare la versione più recente dell'applicazione.
3. Controllare l'elenco Wi-Fi sul proprio smartphone per individuare la rete denominata "WOLFBOX".
4. In caso di messaggio "Connessione non riuscita" nell'app, si prega di trovare "Ottieni supporto" nell'app per contattarci.

Contenido

Producto Especificaciones	92
Apariencia	93
Interfaz de Usuario	94
Descripción General de Funciones	96
Utiliza la APLICACIÓN (Wi-Fi e INFORMACIÓN SOBRE LA APLICACIÓN)	103
Cómo Reproducir Vídeo en el Ordenador	104
Instalación	106
Solución de Problemas	112

Producto Especificaciones

RAM	DDR3 2Gb	Tipo de pantalla	IPS
Formato de vídeo	MP4	Formato de imagen	JPG
Cámara frontal	4K	Cámara trasera	1080P
Tamaño de la pantalla	12"	Lente trasera FPS	25 fps
Interfaz de alimentación	USB-C	GPS	Exteriores, Interfaz para auriculares de 3,5mm
Conexión Wi-Fi	Soportado	Control de voz	Soportado
Temperatura de funcionamiento	-4°F ~ 158°F	Pantalla táctil	Soportado
Tarjeta SD	Max Suppok 512GB		

Apariencia

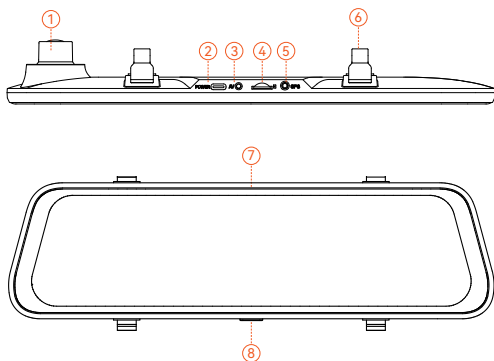



NO.	Nombre	Descripción
1	Lente	Lente frontal, graba la vista frontal del coche
2	Puerto USB-C	Puerto para alimentación/conexión
3	Cámara trasera	Puerto utilizado para conectar la cámara trasera
4	Ranura para tarjeta TF	Proporciona almacenamiento ampliable (clase 10 Máx 256 GB)
5	Conector GPS	Se utiliza para conectar el módulo GPS (La función GPS requiere una antena GPS opcional)
6	Sujetadores	La máquina se puede mantener en posición con 2 correas
7	Pantalla de visualización	Pantalla táctil de 12"
8	Botón de encendido	Pulsación corta para despertar/dormir, pulsación larga para encender/apagar

Interfaz de Usuario



ícono	Descripción
	Velocidad y dirección de conducción: Una vez conectado el GPS, se mostrará la información adecuada
	Fecha y Hora
	Activa/Desactiva el sonido del dispositivo
	Activa/Desactiva el Wi-Fi
	Ver las opciones de los comandos de voz
	Iniciar/Detener Grabación
	Ajustar el brillo de la pantalla
	Basculer entre vue de cámara avant, arrière et écran partagé
	Instantánea: Tomar una instantánea
	Estado de grabación: el amarillo parpadeante indica grabación bloqueada (el vídeo grabado no se sobrescribirá)

icono	Descripción
	Reproducción de archivos: reproduce videos y fotos
	Activar/desactivar la grabación de audio
	Configuración: toque para ingresar al menú de configuración

• Modo de reproducción







Cuando enciendas la cámara del tablero, comenzará a grabar automáticamente. Haga clic/seleccione  para ingresar al modo de reproducción.













	Guarda imágenes capturadas por la cámara frontal		Guarda imágenes capturadas por la cámara trasera
	Videos Normales: Seleccionalo para ver los videos grabados		Videos Bloqueados: Seleccionalo para revisar los videos bloqueados
	Fotos: Seleccionalo para ver las fotos		Selecciona
	Elimina		Bloquea el video
	Ver los videos en pantalla completa		







Descripción General de Funciones







Haga clic en el icono de configuración para ingresar al menú de funciones, donde puede ajustar varias funciones y parámetros de toda la máquina.

Función	Opción	Descripción
 Resolución	4K30fps+1080P25fps/ 2.5K30fps+1080P25fps/ 1080P30fps+1080P25fps	Selección de la resolución de video.
 Modo de visualización	Cámara frontal/Cámara trasera/Visualización en pantalla dividida	Configurar la pantalla de visualización estándar al inicio para la grabación de video.
 Grabación de sonido	Apagado/Encendido	Configurar si se graba el audio.
 Duración de grabación	1 minuto/2 minutos/ 3 minutos	Configurar la duración de la grabación cíclica.
 Sensibilidad a las colisiones	Apagado/Bajo/ Intermedio/Alto	Después de detectar una colisión/impacto, el dispositivo bloquea el video grabado.
 Recordatorio de fatiga	Apagado/1 hora/2 horas/3 horas	Configurar el tiempo para la alerta de fatiga.

Función	Opción	Descripción
 Wi-Fi	Apagado/Encendido	Configurar el tiempo de activación del protector de pantalla.
 Volumen	Apagado/Bajo/ Intermedio/Alto	Configurar el volumen.
 Sonido del botón	Apagado/Encendido	Configurar la opción para los tonos de teclado.
 Protector de pantalla	Chiu di/10 secondi/ 30 secondi/2 minuti	Configurar el estado de la conexión Wi-Fi del dispositivo.
 Brillo de la pantalla	/	Configurar el brillo de la pantalla.
 Exposición	/	Configurar el contraste de la cámara frontal.
 Control por voz	Apagado/ Encendido/Control por voz	Configurar la opción para la función de control de voz.

Función	Opción	Descripción
 <p>Espejo de la cámara trasera</p>	Apagado/Encendido	Configurar la inversión izquierda-derecha de la imagen de la cámara trasera.
 <p>Inversión retrocamera</p>	Apagado/Encendido	Configurar la inversión arriba-abajo de la imagen de la cámara trasera.
 <p>Modo de línea de marcha atrás</p>	Apagado/Encendido	Configurar la opción para la función de visualización de líneas de retroceso.
 <p>Control de aparcamiento</p>	Apagado/Grabación de disparos G/ Grabación de intervalo de 12 horas/ Grabación de intervalo de 24 horas/ Grabación de intervalo de 48 horas	Monitorizar el estado del vehículo después de apagar el motor.
 <p>GPS</p>	/	Ver los datos GPS registrados.
 <p>Visualización GPS</p>	Apagado/Encendido	Configurar si mostrar las informaciones GPS en la pantalla de grabación.

Función	Opción	Descripción
 Marca de agua de tiempo	Apagado/Encendido	Activar la opción para la marca de tiempo de la fecha.
 Marca de agua de velocidad	Apagado/Encendido	Activar la opción para la marca de tiempo de la velocidad.
 Marca de agua GPS	Apagado/Encendido	Activar la opción para la marca de tiempo GPS.
 Unidad de velocidad	KM/H / MPH	Configurar la unidad para la visualización de la velocidad.
 Idioma	English/Français/ Deutsch/Italiano/ Español/...	Configurar el idioma para el dispositivo.
 Ajuste del reloj	/	Configurar la hora actual en el dispositivo.
 Formato de hora	YY-MM-DD /DD-MM-YY /MM-DD-YY	Configurar el formato de visualización de la fecha.

Función	Opción	Descripción
 Formato de hora	12 horas/24 horas	Configurar el sistema de visualización de la hora.
 Zona horaria	/	Configurar la zona horaria según la ubicación geográfica.
 Horario de verano	Apagado/Encendido	Activar/Desactivar la conversión para el horario de verano.
 Frecuencia estroboscópica	50 Hz/60 Hz	Información de contacto para el servicio de atención al cliente.
 Centro de ayuda	/	Configurar el recordatorio para el formateo de la tarjeta SD.
 Recordatorio de formato	Chiudi/Ogni 15 giorni/Ogni 25 giorni	Configurar la frecuencia del recordatorio para el formateo de la tarjeta SD.
 Formatear tarjeta SD	/	Formatear la tarjeta SD y borrar los videos y fotos guardados en ella.

Función	Opción	Descripción
 Restaurar ajustes de fábrica	/	Restaurar todas las configuraciones a los ajustes de fábrica.
 APP	/	Proporcionar un código QR para descargar la aplicación.
 Información del producto	/	Ver la información del dispositivo.

Nota:

El modo de estacionamiento requiere un kit de hardware (se compra por separado) para poder activarse.

Con el kit de hardware conectado y el modo de estacionamiento habilitado, la cámara del tablero ingresará al modo de grabación de intervalos cuando el automóvil se apague. Este modo captura vídeo a 1 fotograma por segundo hasta que finaliza la duración establecida o el voltaje de la batería del coche cae por debajo de 12 V.

Función de control de voz

Control rápido mediante simples comandos de voz

Cuando el icono  es blanco, significa que la función puede usarse normalmente.

Puedes activar/desactivar la función de control de voz desde el menú "Control de voz".

lock the video	
take picture	
turn on audio	turn off audio
turn on screen	turn off screen
turn on Wi-Fi	turn off Wi-Fi
turn on recording	turn off recording
show front camera	show rear camera

Nota:

Tienes dos maneras de ver los comandos de voz específicos:

- 1 Toca el icono de control de voz  en la pantalla de grabación.
- 2 Toca el submenú "Control por voz" debajo de la función "Control de voz".

Utiliza la APLICACIÓN (Wi-Fi e INFORMACIÓN SOBRE LA APLICACIÓN)

La función Wi-Fi te permite conectar tu cámara de salpicadero de forma inalámbrica a tu teléfono inteligente, para acceder instantáneamente a las grabaciones. Desde aquí, podrás ver, descargar y compartir tus videos fácilmente con amigos y familiares.

La aplicación "WOLFBOX" es gratuita y te permite controlar esta cámara de conducción con WLAN integrada directamente desde tu teléfono inteligente.

• ¿Cómo conectarse al Wi-Fi?

1. Descarga la aplicación "WOLFBOX"

Visita la siguiente dirección para descargar la aplicación "WOLFBOX": <https://wolfbox.com/app/>. También puedes escanear el código QR con tu teléfono inteligente para acceder a la página de descarga.



2. Activa el Wi-Fi

Ve a los Ajustes de tu dispositivo y activa el Wi-Fi. En la pantalla del dispositivo aparecerán el nombre y la contraseña de la red Wi-Fi.

3. Conecta al Wi-Fi

Para conectar tu iPhone o teléfono Android a la red Wi-Fi del G850, ve a Ajustes > Wi-Fi, elige la red "G850 Wi-Fi" e introduce la contraseña predeterminada: 12345678.

4. Abre la aplicación "WOLFBOX"

Una vez que tu teléfono esté conectado a la red Wi-Fi del G850, abre la aplicación WOLFBOX. La cámara se sincronizará automáticamente, y podrás ver la transmisión de video en vivo directamente en tu teléfono.

• Modifica y comparte tus videos en la App

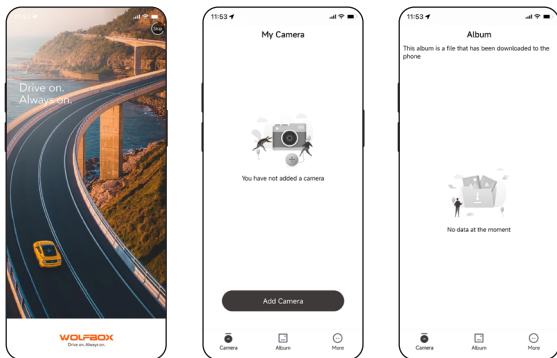

En la app, puedes ver y editar álbumes locales descargados y compartílos con otros.

Cómo Reproducir Vídeo en el Ordenador

Recomendamos la aplicación "GPS Media Player" para ver y reproducir videos de la cámara del tablero y ver Google Maps.

Puede descargarlo gratuitamente en Mac o Windows desde el siguiente enlace: <https://wolfbox.com/gps-player/>

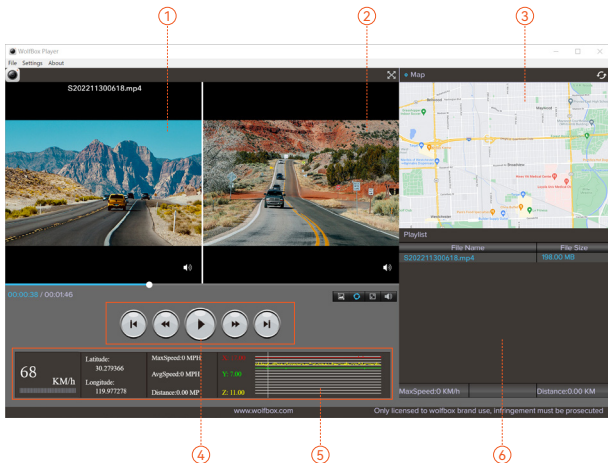

① Ventana de reproducción de video (frontal)

② Ventana de reproducción de video (trasera)

③ Visualización de mapas y rutas

④ Panel de control de reproducción

⑤ Indicación de velocidad y estado de conducción

⑥ Lista de reproducción

Nota:

Si graba los videos de la cámara del tablero delantera y trasera simultáneamente y los agrega a la lista de reproducción, puede reproducirlos uno al lado del otro en modo de pantalla dividida.

Para reproducir un archivo de video, arrástrelo y suéltelo en el reproductor de video.

Instalación

Antes de instalar su cámara de tablero, pruebe su funcionalidad con todos los accesorios y cambie la configuración predeterminada según sus preferencias.

• Instalación de la tarjeta SD

Asegúrese de que la cámara del tablero esté apagada al insertar o expulsar la tarjeta SD.

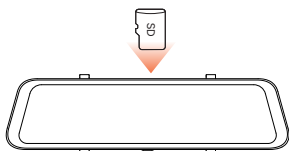

• The Front view of the host

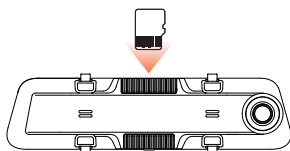

• The Back view of the host

• Instalación de la unidad

1. Coloque la unidad principal (espejo Wolfbox) en el espejo retrovisor con la mano y asegúrese de separar los soportes de silicona en ambos lados del espejo retrovisor. Abroche el dispositivo al espejo retrovisor con las correas de goma. Ajuste la lente frontal al ángulo deseado.

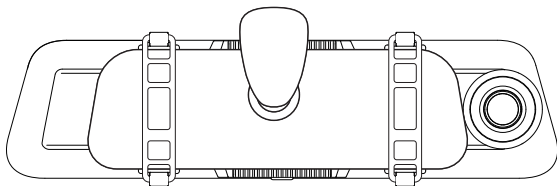

2. Conecte el cargador del automóvil al adaptador del cargador para suministrar energía a la cámara del tablero.

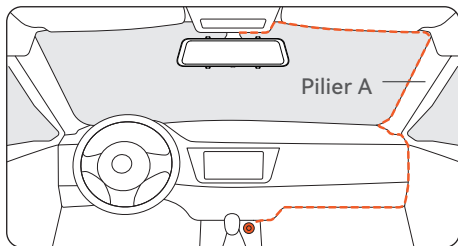

• Encendido/Apagado

- Presione brevemente el botón de encendido para encender, presione prolongadamente el botón de encendido para apagar.
- Cuando utilice el cargador del automóvil, si el puerto del encendedor de cigarrillos es ACC, la cámara del tablero se encenderá automáticamente cuando se encienda el automóvil.

• Rear camera installation

Si no necesitas ajustar el ángulo, puedes quitar esta plancha de hierro.

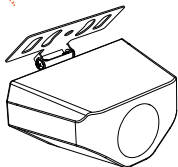

- Fuera del soporte del coche

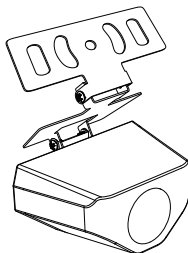

- Dentro del soporte del coche

• Instrucciones de Cableado de la Cámara Trasera

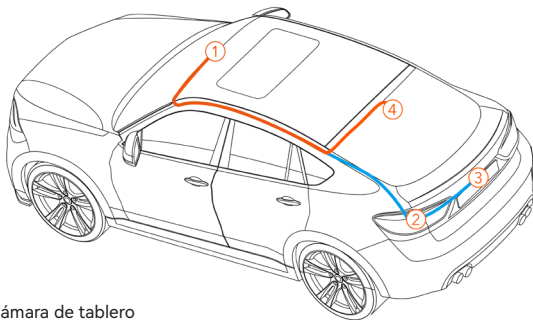

- ① Cámara de tablero
- ② Conectada a la luz de marcha atrás
- ③ Soporte exterior del coche
- ④ Dentro del soporte del coche

Nota:

La cámara trasera tiene dos opciones de enrutamiento de cables, las cuales ocultan el cable a lo largo de los bordes de la puerta.

1. Conecta el cable de la cámara trasera al retrovisor

Conecte el cable de la cámara trasera a la interfaz AV de la unidad.

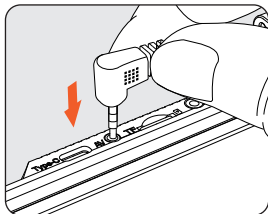

2. Enrutamiento del cable de la cámara trasera

Pase el cable de la cámara trasera hacia la parte trasera del automóvil, dejando algo de holgura. Inserte el cable en el espacio del parabrisas delantero y a lo largo del extremo superior de la puerta con la herramienta incluida.

Si elige instalar la cámara trasera dentro de su automóvil, fíjela en el parabrisas trasero después de pasar el cableado.

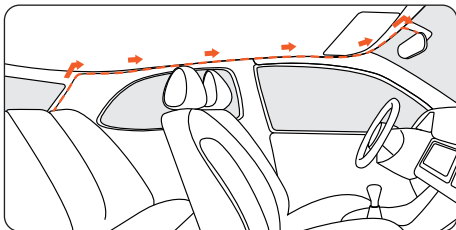

3. Retire el panel

Abra el maletero y retire el panel interior que cubre el otro lado del área de montaje de la matrícula. Utilice una herramienta para quitar molduras u otro dispositivo delgado para abrir el panel.

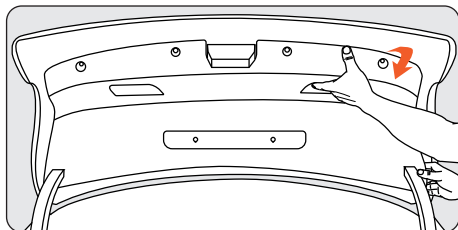

4. Fija la cámara trasera y conecta los cables

Fije la cámara trasera cerca de la luz de la matrícula con pegamento y conecte el cable de la cámara trasera a través del orificio de la luz de la matrícula al cable de la cámara trasera.

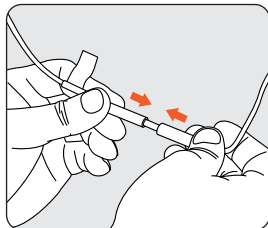
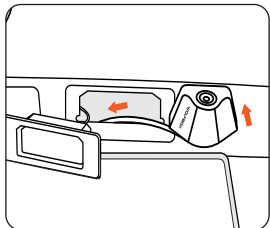

5. Conecte el cable rojo al terminal positivo de la luz de marcha atrás

Encuentra el terminal positivo de la luz de marcha atrás. Este es el terminal que tiene voltaje cuando el auto está en marcha atrás. Para encontrarlo, pise los frenos, ponga el auto en marcha atrás y mida el voltaje en cada terminal. El terminal con voltaje es el terminal positivo. Pela el cable positivo y envuélvelo con el cable rojo de la cámara. Aísle la conexión con cinta aislante. Pruebe la conexión poniendo el automóvil en marcha atrás y viendo si la cámara del tablero entra en modo de marcha atrás.

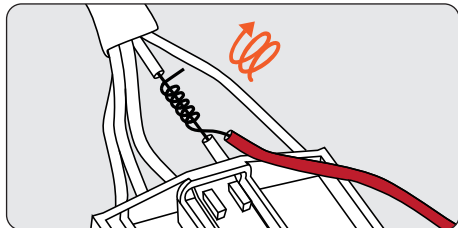

• Instalación del GPS

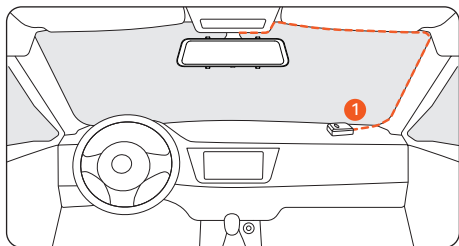

Posición 1:

Instale la cámara del tablero en la esquina derecha de la consola central y oculte el cableado a lo largo del borde del parabrisas delantero con cinta adhesiva de doble cara.

- Teniendo en cuenta el efecto de uso y la conveniencia de la instalación, generalmente recomendamos a los clientes que lo instalen en la posición 1.
- También puede probar diferentes ubicaciones para la cámara del tablero para encontrar la que funcione mejor para usted. Solo asegúrese de que el lado negro esté hacia arriba para recibir la señal de GPS.
- Una vez instalado el GPS, aparecerá el icono de GPS en la pantalla de inicio. Una vez recibida la señal de GPS, el GPS del dispositivo mostrará la dirección y la velocidad.



Resolución de Problemas

- **¿Puede obtenerse la función Wi-Fi mediante la actualización del firmware?**

La Wi-Fi del G850 es una actualización de hardware de una versión anterior, y su función Wi-Fi no puede obtenerse mediante una actualización de firmware.

- **¿Pueden transmitirse las imágenes de la cámara trasera de forma inalámbrica?**

El G850 Wi-Fi incluye un cable para la cámara trasera a través del cual se transmite el video de la cámara trasera. La función Wi-Fi solo se utiliza para conectar el teléfono a la cámara de salpicadero.

- **¿Es posible monitorizar el vehículo de forma remota vía Wi-Fi en el G850?**

Debido al alcance limitado de la Wi-Fi, no es posible monitorizar el vehículo de forma remota a través de la aplicación conectada al G850.

- **¿Imagen de la cámara trasera borrosa o no detectada?**

En caso de problema de "imagen trasera borrosa", asegúrese de quitar la película protectora de la lente y limpiarla con un limpiador. Si los problemas de enfoque son causados por altas temperaturas, póngase en contacto con nosotros para obtener asistencia.

Si aparece el error "Cámara trasera no detectada", revise la entrada AV en la parte superior del espejo y el cable de la cámara trasera para detectar daños, especialmente en el conector.

- **¿Cómo conectar la unidad a la aplicación vía Wi-Fi?**

Asegúrese de que la Wi-Fi esté activada manualmente en la configuración.

Busque "WOLFBOX" en la tienda de aplicaciones para descargar la última versión de la aplicación.

Revise la lista de Wi-Fi en su teléfono inteligente para ver si puede encontrar la red llamada "WOLFBOX".

Si la aplicación muestra "Conexión fallida", busque "Obtener asistencia" en la aplicación para ponerse en contacto con nosotros.

Customer Service Center

If you have any problems with the function or installation, please contact us with any questions.



Help Center



WhatsApp



For more information:

✉ service@wolfbox.com

🌐 www.wolfbox.com

💬 <https://wolfbox.com/contact-us>

WOLFBOX

Dare to Everywhere

Check us out here!
Product and service are the foundation of WOLFBOX.

Email: service@wolfbox.com
Phone: +1 888 296 8399



www.wolfbox.com